

Specification

YS-M66

Digital Sign Board

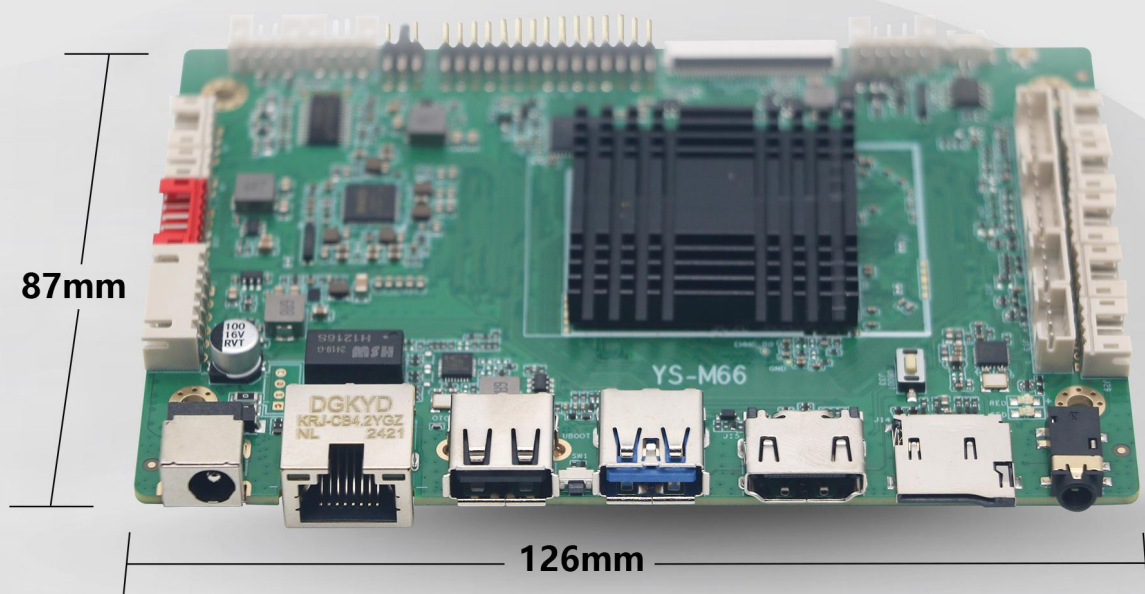

Contents

Declaration	1
Revision History	1
Chapter 1 Product Introduction	2
1.1 Overview	2
1.2 Pictures and Dimensions	2
1.3 Product Detailed Parameters	4
1.4 Configuration & General Precautions	5
Chapter 2 Interface Pin Name	6
Chapter 3 Electrical Characteristics	11
Chapter 4 System Instruction	13
4.1 Android System Interface Description	13
4.2 Network Interface Explanation	14
4.3 Viewing Storage and Memory	16
4.4 Setting The Notification Bar And Navigation Bar	17
Chapter 5 Contact Us	18

Declaration

Images and specifications mentioned in this document are for reference only. Any further changes or updates will not be sent to you unless special contract signed. This document serves as a product guide and the statements made in it do not constitute any form of guarantee. Without the written permission of Yisheng Technology Co., Ltd., no individual or organization may reproduce any part of this document or engage in any form of dissemination for profit. In order to obtain the latest version of product information, please visit Yisheng Technology Co., Ltd.'s official website regularly or contact company staff for assistance. Thank you for your understanding and support!

Revision History

Version	Date	Author	Approver	Description
V1.0	2023.02.28	Zhang Wenjuan	Qin Yongling	Initial version
V2.1	2024.01.10	Zhang Wenjuan	Qin Yongling	Change motherboard picture
V2.3	2024.10.22	Zhang Wenjuan	Li Quan	Change wifi module picture
V2.4	2024.11.06	Zhang Wenjuan	Li Quan	Change Bluetooth parameters

Chapter 1 Product Introduction

1.1 Overview

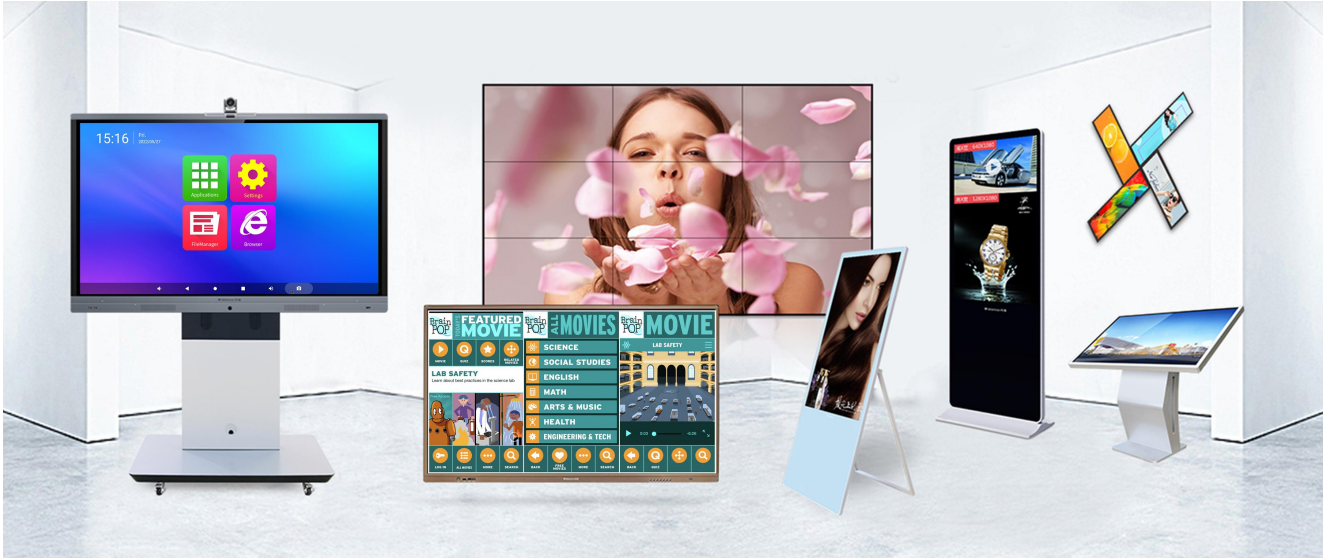

YS-M66 is developed based on Rockchip RK3566, the CPU is Quad-core Cortex-A55, NPU supports 1TOPS, with rich peripheral interfaces, support LVDS, MIPI, HDMI 2.0 output, GPIO, I2C, UART, etc. It can be widely used in mobile internet devices and AIoT devices.

1.2 Pictures and Dimensions

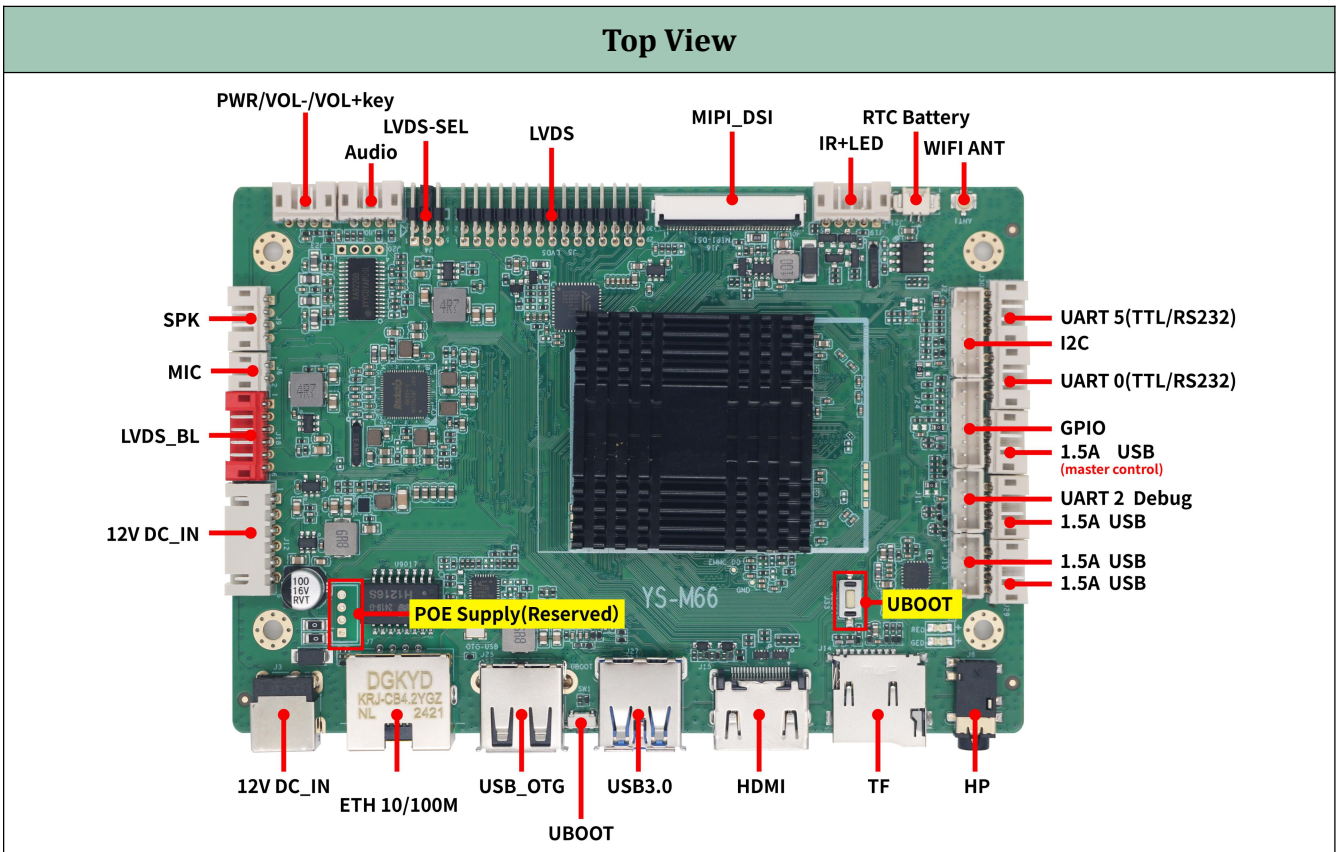

Bottom View

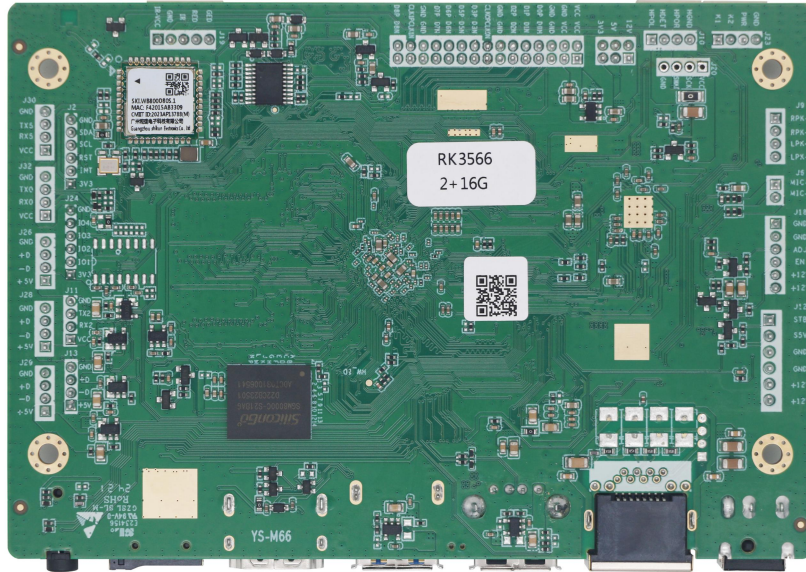

Dimensions

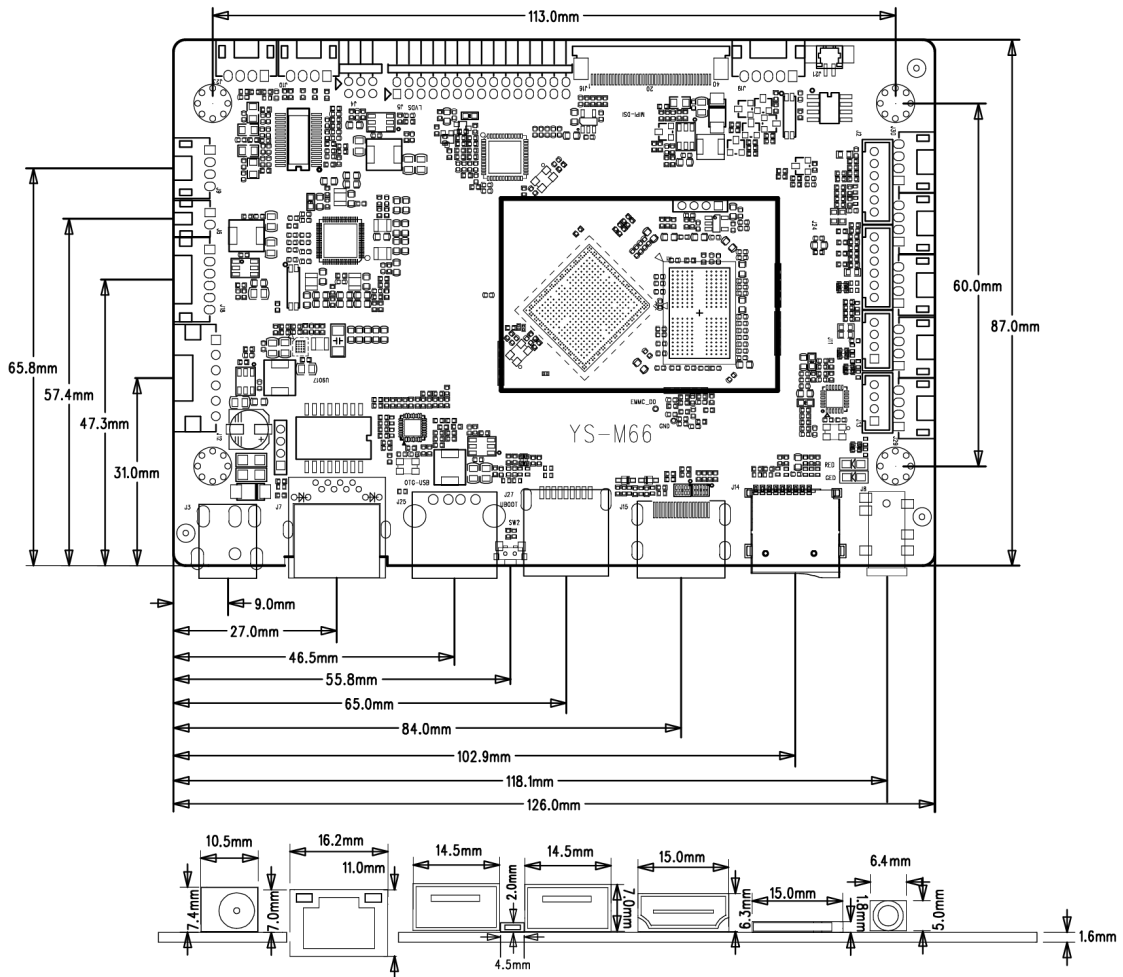

*PCBA L: 126mm

*PCBA W: 87mm

*PCBA H: 12mm

*PCBA Location Hole: $\Phi 3.2\text{mm} \times 4$

1.3 Product Detailed Parameters

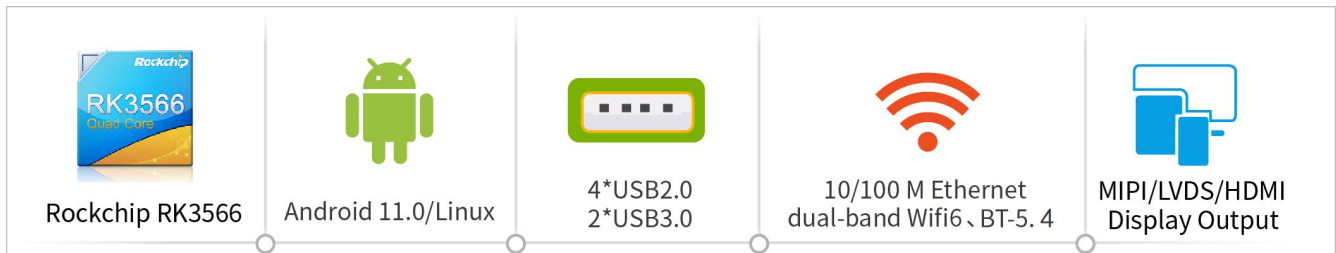

Detail Specification

SOC	RockChip RK3566
CPU	Quad-Core Cortex-A55 Max CPU frequency: 1.8GHz
GPU	ARM Mali-G52-2EE, Embedded 3D GPU OpenGL ES 1.1/2.0/ 3.2 OpenCL up to 2.0 Vulkan 1.1 Special 2D hardware engine
NPU	Support 1TOPS Supports INT8/INT16/FP16/BFP16 MAC hybrid operation
OS	Android: Android 11.0 Linux: Debian11
Video CODEC	Video Decoder 4K@60fps H.264 AVC/MVC/, H.265 HEVC/MVC ,VP9 1080P@60fps MPEG-4/-2/-1/VC-1,VP8 Video Encoder 1080P@60fps H.264/AVC BP/MP/HP ,H.265/HEVC MP
ROM	2GB (Up to 4GB) 32bit LPDDR4
Storage	8/16GB (Up to 128GB) EMMC
Display Output	1*HDMI2.0 (Up to 4K@60HZ) 1*LVDS (Up to 1920x1080) 1*MIPI-DSI-40PIN-FPC (Up to 1200x1920)
Audio	1*SPK (L&R audio-out, Up to 2*8Ω/5W speaker) 1*HP (CTIA) 1*MIC
Network	Ethernet: Support 10/100M WIFI: Dual-Band WIFI6 Bluetooth: 5.4
USB	1*Type-A USB2.0 (OTG or HOST) 1*Type-A USB3.0 HOST 4*USB2.0 HOST(4Pin*2.0mm Wafer)

UART	3*TTL(2*optional TTL or RS232, 1* Debug TTL)
Other	1*I2C 4*GPIO 1*IR+LED 3*Key (1*PWR_Key,2*Vol_Key)

1.4 Configuration & General Precautions

1. Relative humidity $\leq 85\%$
2. Storage temperature: $-30\text{ }^{\circ}\text{C}$ to $+70\text{ }^{\circ}\text{C}$
3. Operating temperature: $-15\text{ }^{\circ}\text{C}$ to $+60\text{ }^{\circ}\text{C}$
4. During the assembly of the whole machine, please do not operate the wiring with power to avoid short circuit between bare board and peripheral equipment.
5. Pay attention to the anti-static treatment during the assembly and transportation of the whole machine, and it is necessary to wear electrostatic protection tools such as electrostatic bracelet (sleeve).
6. When assembling the whole machine, it can be installed at the bottom or side, but do not deform or twist the board, and do not bear heavy pressure.
7. Proper distance shall be reserved at the wiring position of each terminal to avoid squeezing the terminal during installation.
8. The connecting line between this board and the supporting module board should not be too long, otherwise it may affect the image quality.
9. The internal wiring of the whole machine shall be reasonable, and the connecting wires shall not pass through the PCB board directly as far as possible.
10. In order to achieve better EMC effect for the whole machine, it is recommended that the screen wire between the main board and the screen should be shielded wire.
11. The specifications of the peripherals connected to the installation shall be confirmed with our company, including but not limited to: voltage limit, current limit, timing, power domain, etc.

Chapter 2 Interface Pin Name

J12 (4PIN/2.54) 12V PWR_IN

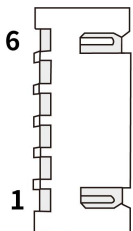
Exterior	Pin No.	Pin Name	Description
	1	STB	Power supply enable, connect to PSON
	2	S5V	5V constant power supply (standby), connect to 5VS
	3	GND	Ground
	4	GND	Ground
	5	+12V	12V Power Input
	6	+12V	12V Power Input

J18 (6PIN/2.0) LVDS_BL

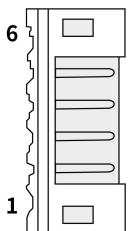
Exterior	Pin No.	Pin Name	Description
	1	GND	Ground
	2	GND	Ground
	3	ADJ	Backlight Brightness Adjustment
	4	EN	Backlight On/Off Control
	5	+12V	Screen Backlight Power Supply
	6	+12V	Screen Backlight Power Supply

J6 (2PIN/2.0) MIC

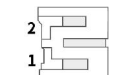
Exterior	Pin No.	Pin Name	Description
	1	MIC+	Positive input for local microphone
	2	MIC-	Negative input for local microphone

J9 (4PIN/2.0) SPK

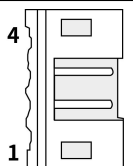
Exterior	Pin No.	Pin Name	Description
	1	RPK+	Positive output for right Channel
	2	RPK-	Negative output for right Channel
	3	LPK-	Negative output for left Channel
	4	LPK+	Positive output for left Channel

J23 (4PIN/2.0) PWR/VOL-/VOL+ Key

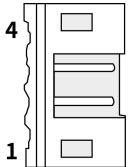
Exterior	Pin No.	Pin Name	Description
	1	K1	Volume up
	2	K2	Volume down
	3	PWR	Power on/off
	4	GND	Ground

J10 (4PIN/2.0) Audio

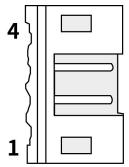
Exterior	Pin No.	Pin Name	Description
	1	HPOL	Left Channel
	2	HDET	Test
	3	HPOR	Right Channel
	4	HGND	Ground

J4 (6PIN/2.0) LVDS_SEL_VOLT

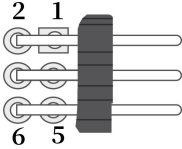
Exterior	Pin No.	Pin Name	Description
	1	12V	12V Power Supply
	2	VCC_LCD	screen voltage port
	3	5V	5V Power Supply
	4	VCC_LCD	screen voltage port
	5	3.3V	3.3V Power Supply
	6	VCC_LCD	screen voltage port

Note: The LVDS screen uses a jumper cap to select the screen power supply. Connect 3.3V to VCC_LCD, then the screen voltage is 3.3V.

J5 (30PIN/2.0) LVDS

Exterior	Pin No.	Pin Name	Description
	1	VCC	Power Supply
	2	VCC	Power Supply
	3	VCC	Power Supply
	4	GND	Ground
	5	GND	Ground
	6	GND	Ground
	7	D0-	LVDS Signal
	8	D0+	LVDS Signal
	9	D1-	LVDS Signal
	10	D1+	LVDS Signal
	11	D2-	LVDS Signal

	12	D2+	LVDS Signal
	13	GND	Ground
	14	GND	Ground
	15	CKO-	LVDS Signal
	16	CKO+	LVDS Signal
	17	D3-	LVDS Signal
	18	D3+	LVDS Signal
	19	D5-	LVDS Signal
	20	D5+	LVDS Signal
	21	D6-	LVDS Signal
	22	D6+	LVDS Signal
	23	D7-	LVDS Signal
	24	D7+	LVDS Signal
	25	GND	Ground
	26	GND	Ground
	27	CK1-	LVDS Signal
	28	CK1+	LVDS Signal
	29	D8-	LVDS Signal
	30	D8+	LVDS Signal

J16 (40PIN/0.5mm) MIPI_DSI (FPC)

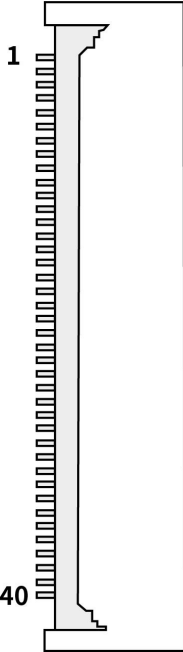
Exterior	Pin No.	Pin Name	Description
	1	VDD1V8	+1.8V Power Supply
	2	VDD3V3	+3.3V Power Supply
	3	VDD3V3	+3.3V Power Supply
	4	NC	Null
	5	RESET	Reset
	6	NC	Null
	7	GND	Ground
	8	MIPI_D0-	MIPI Signal
	9	MIPI_D0+	MIPI Signal
	10	GND	Ground
	11	MIPI_D1-	MIPI Signal
	12	MIPI_D1+	MIPI Signal
	13	GND	Ground
	14	MIPI_CLK-	MIPI Signal
	15	MIPI_CLK+	MIPI Signal
	16	GND	Ground
	17	MIPI_D2-	MIPI Signal
	18	MIPI_D2+	MIPI Signal

	19	GND	Ground
	20	MIPI_D3-	MIPI Signal
	21	MIPI_D3+	MIPI Signal
	22	GND	Ground
	23	NC	Null
	24	NC	Null
	25	GND	Ground
	26	NC	Null
	27	NC	Null
	28	NC	Null
	29	NC	Null
	30	GND	Ground
	31-32	LEDK	Backlight Power Supply
	33	NC	Null
	34	NC	Null
	35	NC	Null
	36	NC	Null
	37	NC	Null
	38	NC	Null
	39-40	LEDA	Backlight Power Supply

J19 (5PIN/2.0) IR+LED

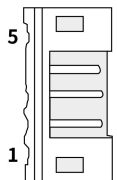
Exterior	Pin No.	Pin Name	Description
	1	VCC	Power Supply
	2	GND	Ground
	3	IR	Remote Control Infrared
	4	RED	Red Light
	5	GED	Green Light

J21 (2PIN/2.0) RTC Battery

Exterior	Pin No.	Pin Name	Description
	1	BAT-	Battery Negative
	2	BAT+	Battery Positive

J2 (6PIN/2.0) IIC (Power Domain3.3V)

Exterior	Pin No.	Pin Name	Description
	1	3.3V	Power Supply
	2	INT	Interrupt
	3	RST	Reset
	4	SCL4	12C Clock
	5	SDA4	12C Data
	6	GND	Ground

J24 (6PIN/2.0) GPIO (Power Domain3.3V)

Exterior	Pin No.	Pin Name	Description
	1	3.3V	Power Supply
	2	IO1	GPIO1
	3	IO2	GPIO2
	4	IO3	GPIO3
	5	IO4	GPIO4
	6	GND	Ground

J11 (4PIN/2.0) UART 2 (Debug TTL UART, Power Domain3.3V)

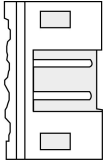
Exterior	Pin No.	Pin Name	Description
	1	VCC	3.3V Power Supply
	2	RX3	UART Receive
	3	TX3	UART Transmit
	4	GND	Ground

J13 (4PIN/2.0) USB

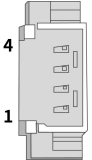
Exterior	Pin No.	Pin Name	Description
	1	+5V	USB Power Supply
	2	D-	USB data-
	3	D+	USB data+
	4	GND	Ground

J30 (4PIN/2.0) UART 5 (TTL, Optional RS232, TTL Power Domain3.3V)

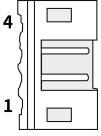
Exterior	Pin No.	Pin Name	Description
	1	VCC	Power Supply 5V (Optional 3.3V)
	2	RX5	UART Receive
	3	TX5	UART Transmit
	4	GND	Ground

J32 (4PIN/2.0) UART 0 (TTL, Optional RS232, TTL Power Domain3.3V)

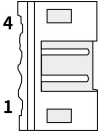
Exterior	Pin No.	Pin Name	Description
	1	VCC	Power Supply 5V (Optional 3.3V)
	2	RX0	UART Receive
	3	TX0	UART Transmit
	4	GND	Ground

J26、J28、J29 (4PIN/2.0) USB

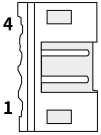
Exterior	Pin No.	Pin Name	Description
	1	+5V	USB Power Supply
	2	D-	USB data-
	3	D+	USB data+
	4	GND	Ground

Chapter 3 Electrical Characteristics

◆ Normal Operating Conditions

Interface Type		Min	Typ	Max
Standard power parameters	Vcc	11V	12V	13.5V
	Ripple	/	/	±3%
	Current	2A	3A	/

◆ Power Consumption

Interface Type		Min	Typ	Max
Power Supply Current (with no display connected)	Operation Current	/	200mA	450mA
	STAND-BY CURRENT	/	18mA	20mA
	BATTERY OPERATION CURRENT	/	0.0024mA	/

◆ USB Power Supply

USB Interface Type	Voltage	Typical Current	Max Current
OTG_USB	5V	500mA	1.5A
HOST_USB	5V	500mA	1.5A

Note: It is recommended that the total current of USB peripheral should not exceed 3000 mA, otherwise the machine will be unable to operate normally.

◆ Other

Interface Type	Rated Current	Max Current	Max Current
EXT 5V	/	3000mA	
EXT 3.3V	/	3000mA	
MIPI_DSI_BL	150mA	/	/

Chapter 4 System Instruction

4.1 Android System Interface Description

The main menu interface of Android system is divided into four categories: application, settings, file management and browser.

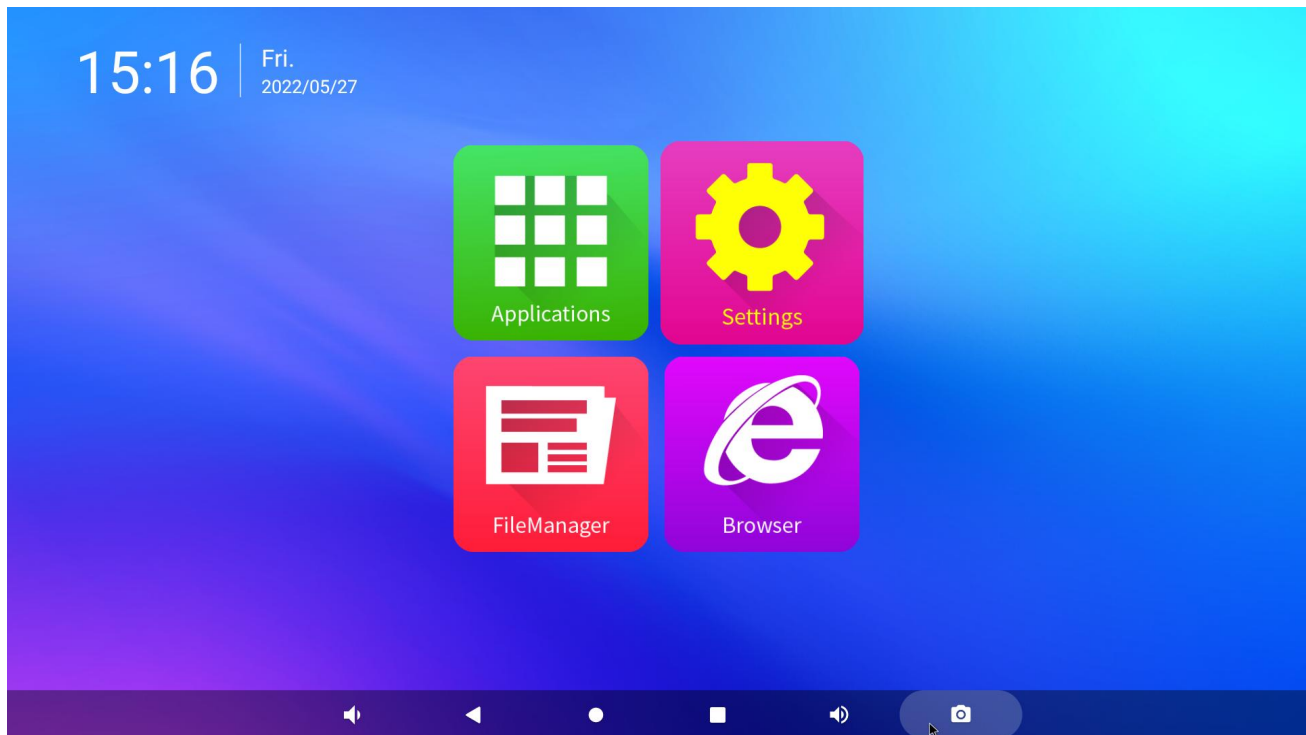

Homepage

(1) Application interface

The application interface includes: Power on / off, settings, gallery, file, camera, music, explorer, browser, etc.

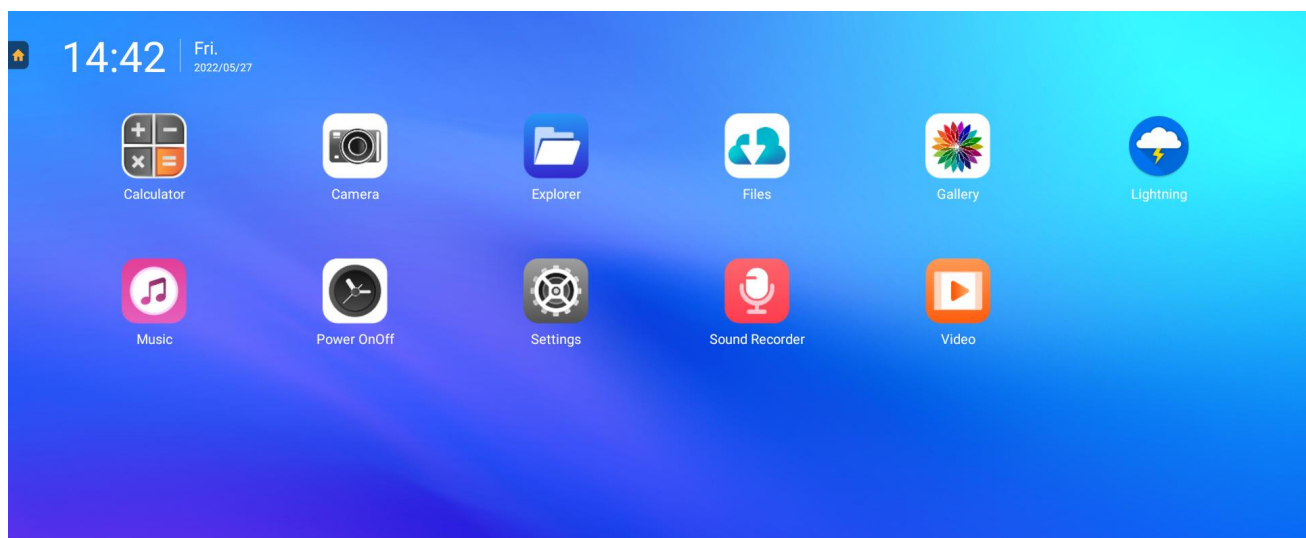

Application Interface

(2) File Management Interface

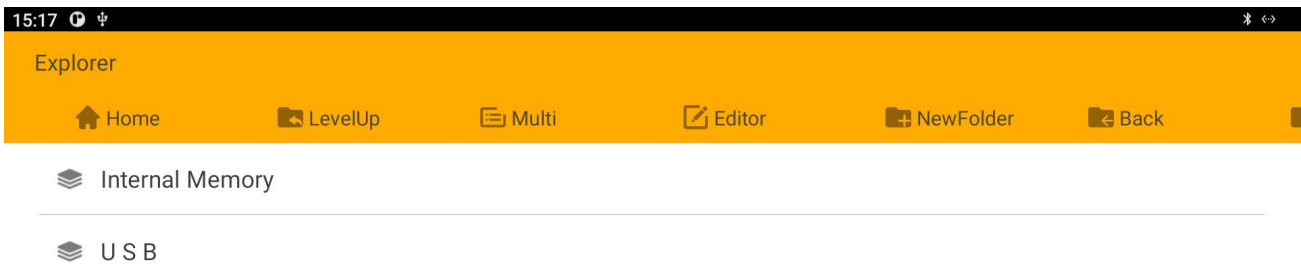

File Management Interface

(3) Setting Menu Interface

It supports the settings of wireless network and device display sound, and can also view the program applications installed on the device, storage memory, etc.

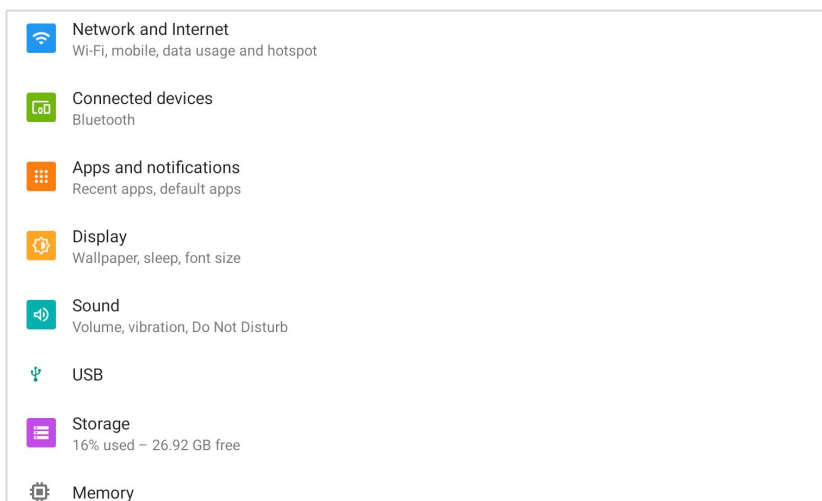

Setting Menu Interface

4.2 Network Interface Explanation

(1) WIFI Network Signal Connection

Turn on the WiFi switch in the "setting" interface, as shown in the following figure; Select the WiFi signal to be connected and enter the corresponding password to successfully connect.

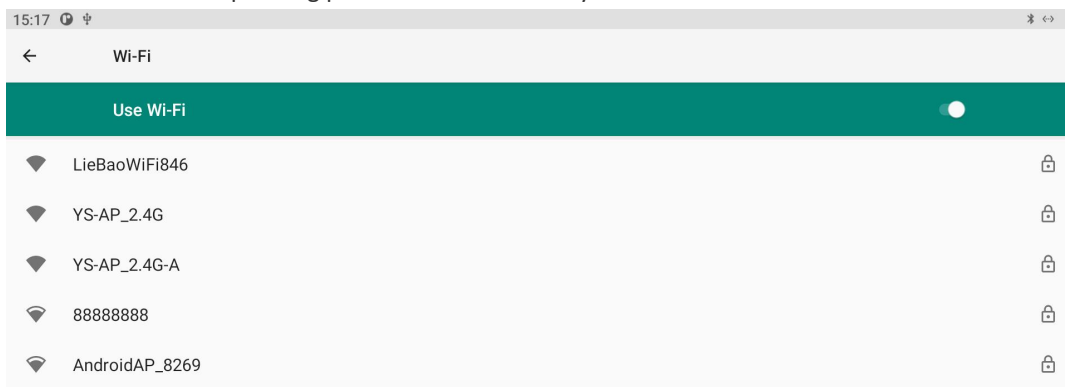

WIFI Setting Interface

(2) WiFi Hotspot

As shown in the following figure, in the "Settings - network and Internet" interface, open the "hotspot and network sharing - WiFi hotspot" function, enter the interface shown in the figure below, you can send WiFi signals, and the device can successfully connect to the hotspot by entering the password.

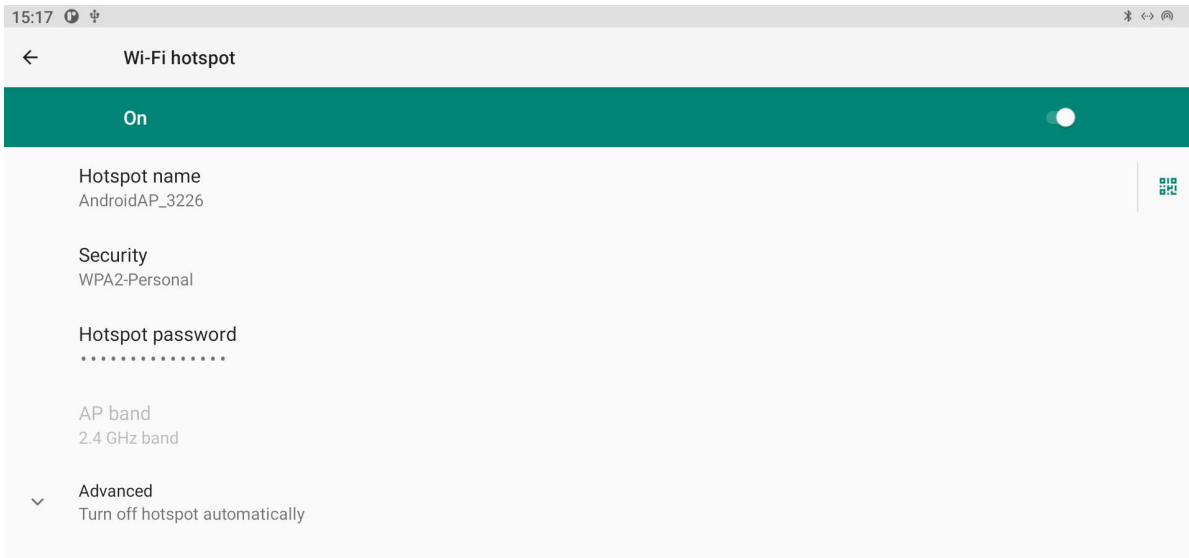

WiFi Hotspot connection interface

(3) Bluetooth Signal Connection

In the "Settings" interface, open the "connected devices" function and enter the "pairing with new devices" interface shown in the figure below to search for Bluetooth devices and pair them.

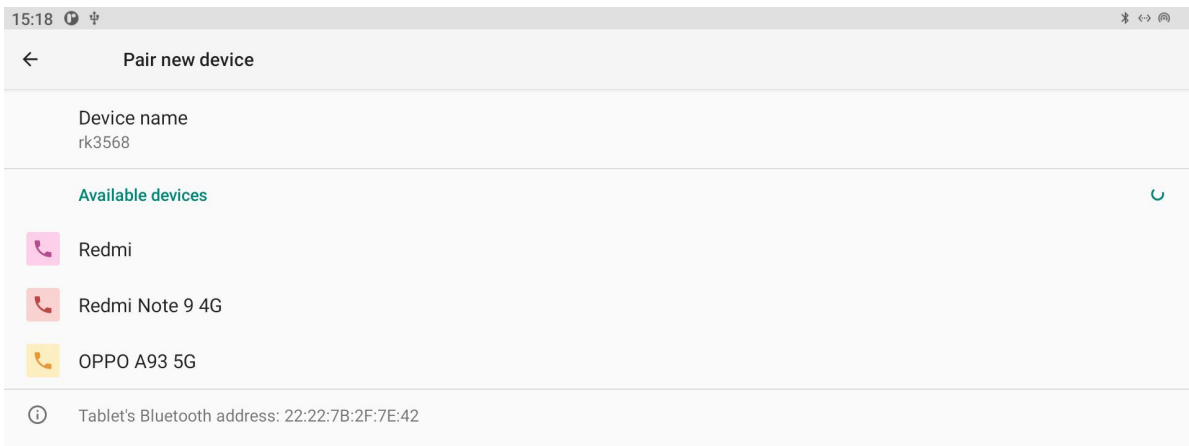

Bluetooth Setting Interface

(4) Ethernet Connection

In the "Settings" interface, enter "network and Internet", turn on Ethernet, enter the page shown in the figure below, turn on the Ethernet switch, then plug in the network cable and automatically connect to Ethernet. You can view the IP address, Ethernet MAC address and other information in the interface shown in the figure below.

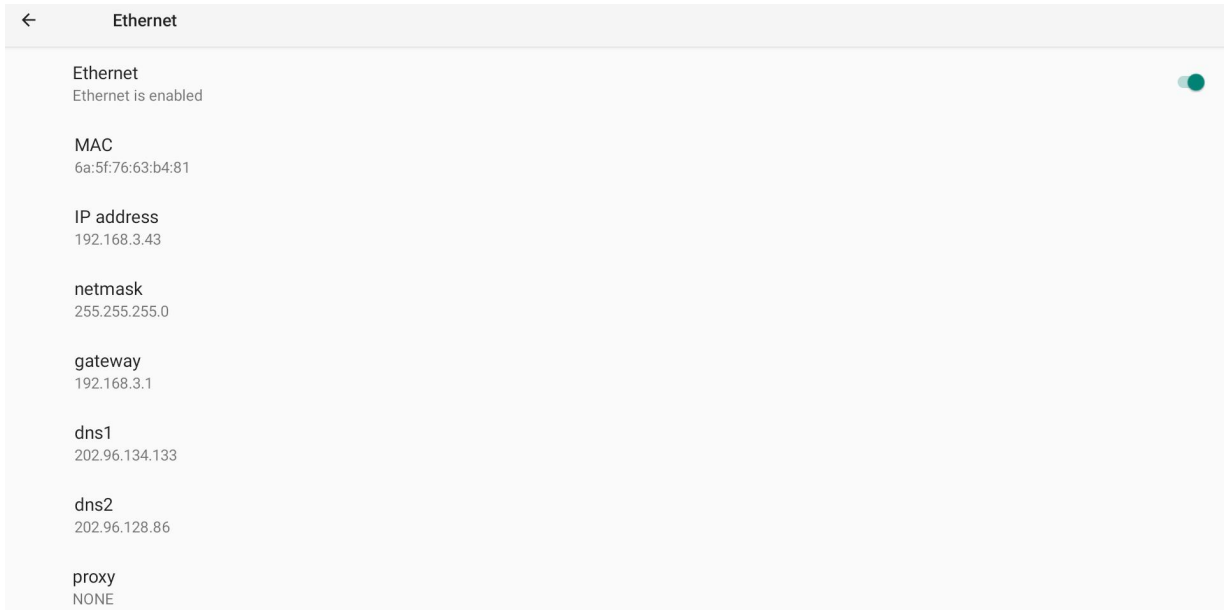

Ethernet Setting Interface

NOTICE:

- THE USE OF THE WIRELESS NETWORK MUST BE CONNECTED TO THE WIFI ANTENNA AT THE WIFI ANTENNA HOLDER
- THE AVAILABILITY AND COVERAGE OF WIFI SIGNALS DEPENDS ON THE NUMBER OF SIGNALS, ANTENNA PERFORMANCE AND EXTERNAL ENVIRONMENT.
- THE ETHERNET MAC ADDRESS IS THE ONLY PERMANENT AND VALID DEVICE ID FOR THIS SYSTEM.

THE NETWORK PRIORITY ORDER FOR ALL ANDROID DEVICES IS:

1. ETH Ethernet network
2. WIFI wireless network
3. 3G/4G/5G mobile network

4.3 Viewing Storage and Memory

In settings, select "storage" to enter the following interface, where the storage information of the storage space will be displayed. The display of 5.08GB capacity is the remaining available storage capacity of the board, and the display of "Total used 32.00GB" is the total storage capacity of the hardware.

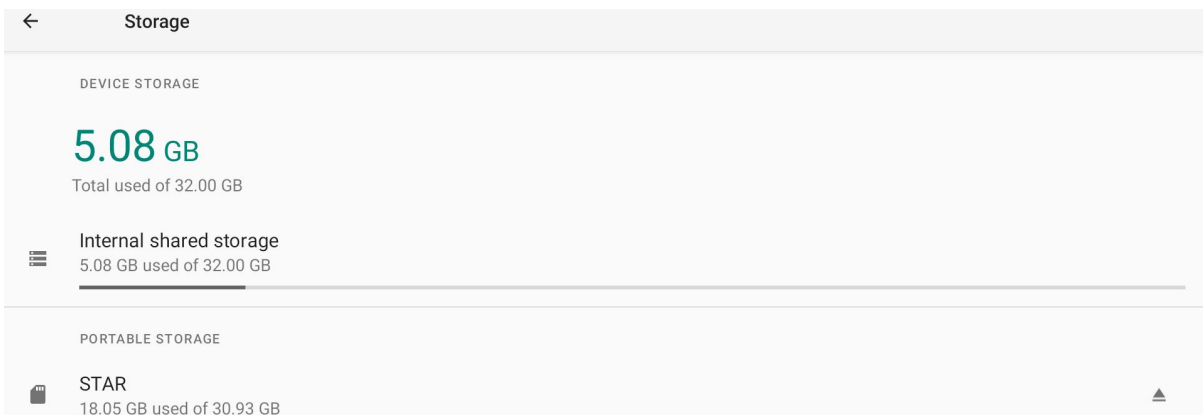

Viewing Storage Interface

In the setting, select "memory" to enter the interface below to display the built-in storage information. The display shows that the capacity of 1.3GB is the remaining memory capacity of the board, and the display of "total memory 4GB" is the total memory.

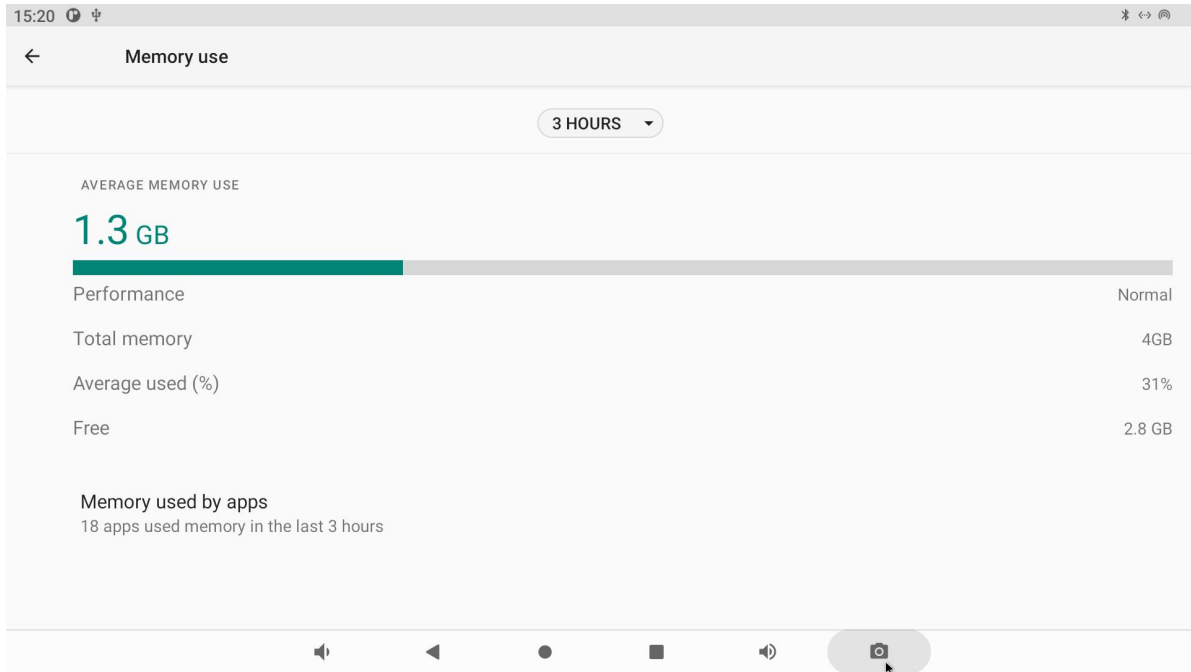

View Memory Interface

4.4 Setting The Notification Bar And Navigation Bar

In the setting, select "display": check "hide navigation bar", and the navigation bar will be hidden; Check "swipe navigation bar", and the navigation bar can be slid out by sliding the mouse up from the bottom. The navigation bar will disappear 5 seconds after no operation. If disable expand statusbar is checked, expand statusbar cannot be pulled down; Check "hide top statusbar" to hide the top statusbar showing time and other statuses at the top of the interface.

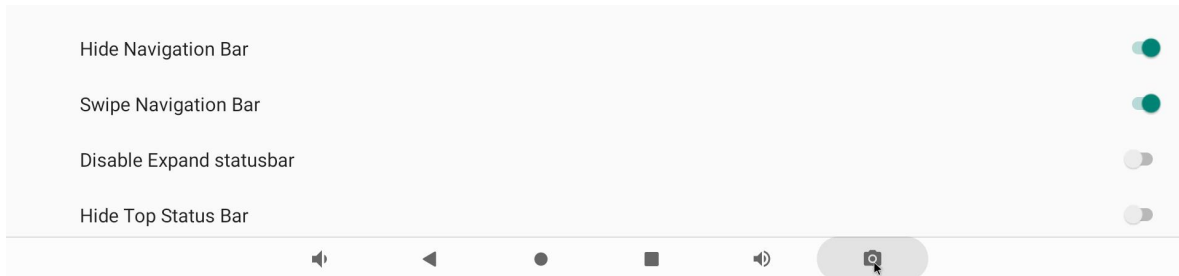

Navigation Bar

NOTE:

"Hide navigation bar" must be selected before "swipe navigation bar" is selected; When hide top statusbar is selected, expand statusbar is also forced to be hidden by default.

Chapter 5 Contact Us



Contact Information:

Tel: 0755-27383670

Email: lisiping@yishengtc.com

Operation Website:

Web: www.yishengtec.cn/en

Office Address:

Shenzhen Headquarters: 6/F, R&D Center, Lixinhu High-tech Industrial Park, Bao'an District, Shenzhen

Guangzhou Branch: Room 318, Jiangrun Building, No. 565, Xingnan Avenue, Panyu District, Guangzhou

Looking forward to working with you, thank you