

# Specification

## YS-F3568

AIOT Board

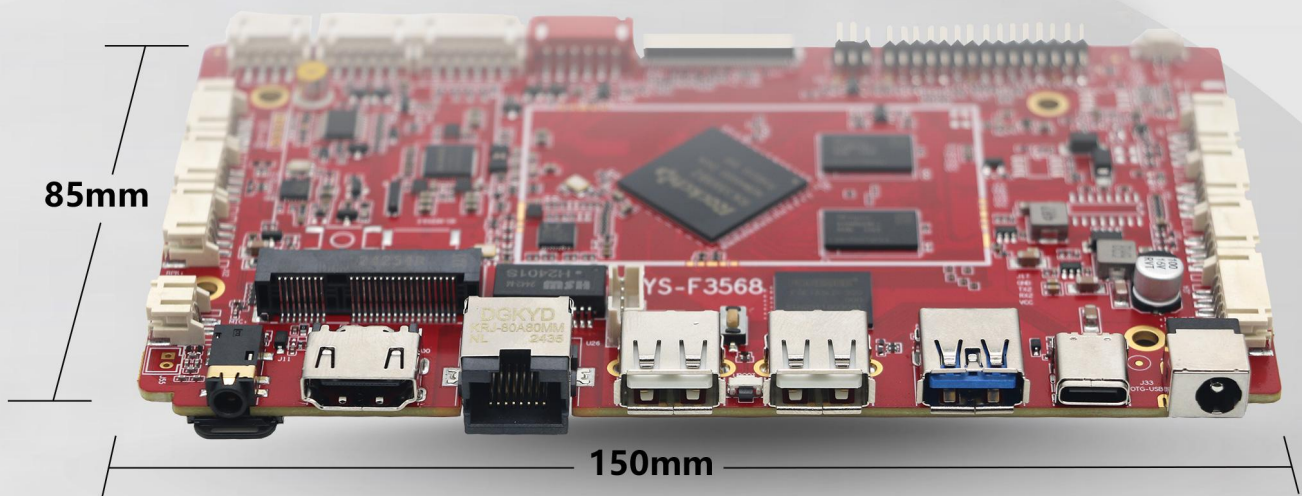

# Contents

Declaration .....	1
Revision History .....	1
Chapter 1 Product Introduction .....	2
1.1 Overview .....	2
1.2 Pictures and Dimensions .....	2
1.3 Product Detailed Parameters .....	4
1.4 Configuration & General Precautions .....	5
Chapter 2 Interface Pin Name .....	6
Chapter 3 Electrical Characteristics .....	13
Chapter 4 System Instruction .....	14
4.1 Android System Interface Description .....	14
4.2 Network Interface Explanation .....	15
4.3 Viewing Storage and Memory .....	18
4.4 Setting The Notification Bar And Navigation Bar .....	19
Chapter 5 Contact Us .....	20

# Declaration

Images and specifications mentioned in this document are for reference only. Any further changes or updates will not be sent to you unless special contract signed. This document serves as a product guide and the statements made in it do not constitute any form of guarantee. Without the written permission of Yisheng Technology Co., Ltd., no individual or organization may reproduce any part of this document or engage in any form of dissemination for profit. In order to obtain the latest version of product information, please visit Yisheng Technology Co., Ltd.'s official website regularly or contact company staff for assistance. Thank you for your understanding and support!

# Revision History

Version	Date	Author	Approver	Description
V1.0	2023.02.28	Zhang Wenjuan	Qin Yongling	Initial version
V1.7	2024.01.10	Zhang Wenjuan	Qin Yongling	Correct description error part
V1.8	2024.10.22	Zhang Wenjuan	Li Quan	Change wifi module picture
V1.9	2024.11.06	Zhang Wenjuan	Li Quan	Change Bluetooth parameters
V2.1	2024.11.12	Zhang Wenjuan	Li Quan	EDP point screen is changed to MIPI point screen, and optional EDP is added to LVDS

# Chapter 1 Product Introduction

## 1.1 Overview



YS-F3568 is developed based on Rockchip RK3568, the CPU is Quad-core Cortex-A55, NPU supports 1TOPS, with rich peripheral interfaces, support LVDS, EDP, HDMI2.0 output, GPIO, I2C, UART, etc. It can be widely used in mobile internet devices and AIoT devices.

## 1.2 Pictures and Dimensions

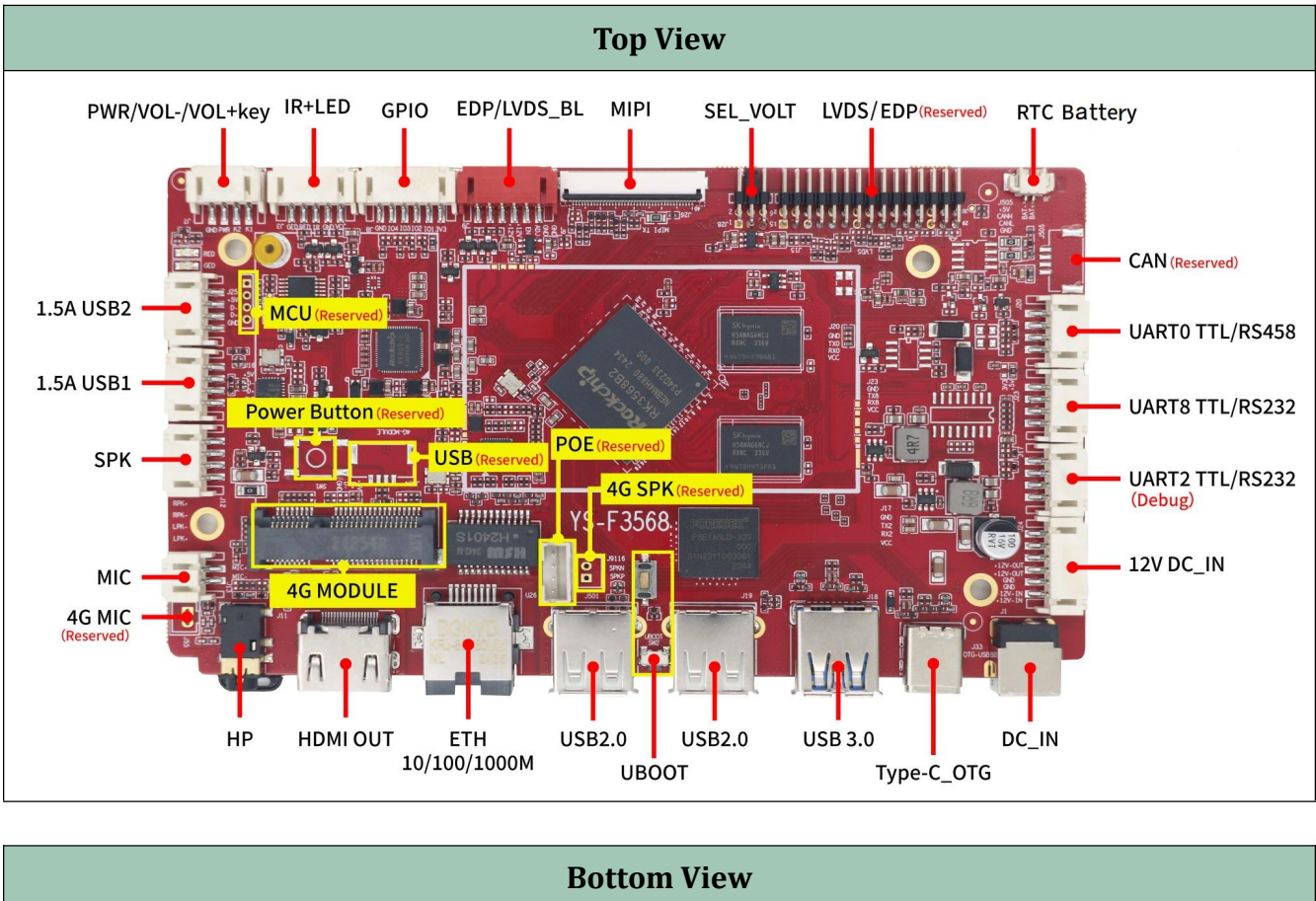

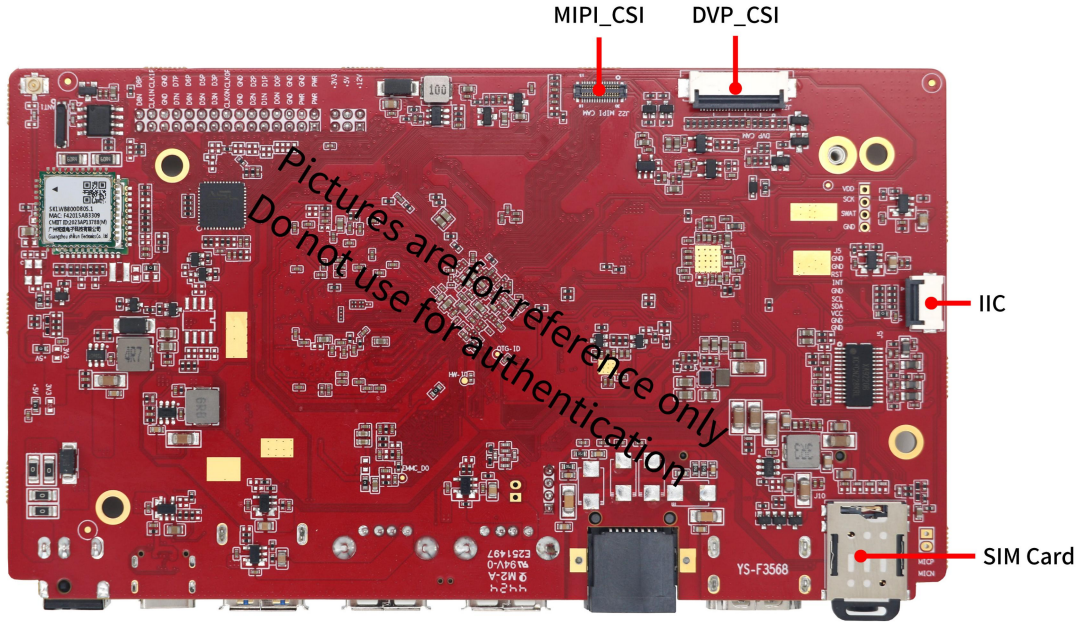

**Dimension**

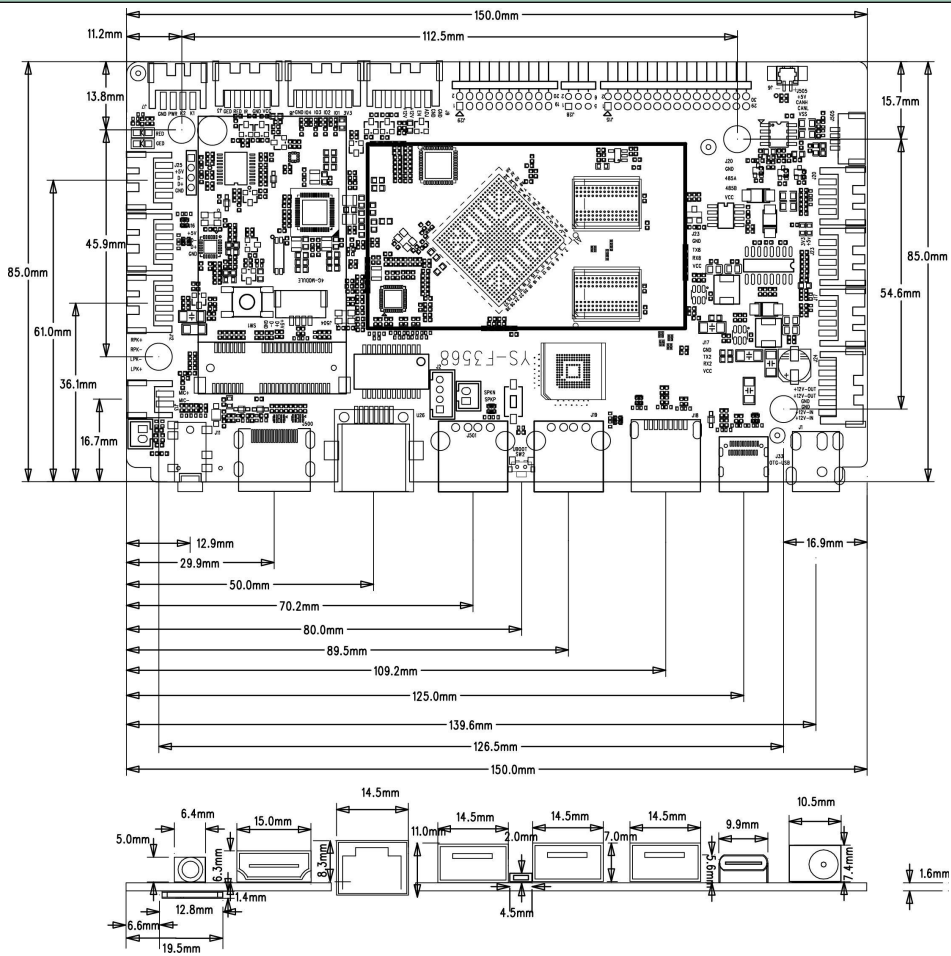

\*PCBA L: 150mm

\*PCBA W: 85mm

\*PCBA H: 12mm

\*PCBA Location Hole:  $\Phi$ 3.4mm x4

## 1.3 Product Detailed Parameters

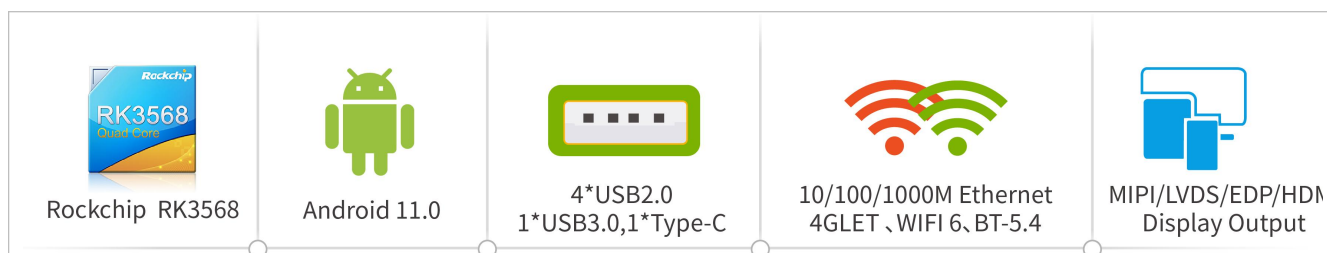

### Detail Specification

<b>SOC</b>	RockChip RK3568
<b>CPU</b>	Quad-Core Cortex-A55 Max CPU frequency: 2.0GHz
<b>GPU</b>	Mali-G52-2EE, Embedded 3D GPU OpenGL ES 1.1/2.0/ 3.2 OpenCL 2.0 Vulkan 1.1 Special 2D hardware engine
<b>NPU</b>	Support 1TOPS Supports INT8/INT16 hybrid operation
<b>OS</b>	<b>Android:</b> Android 11.0 <b>Linux:</b> Debian11
<b>Video CODEC</b>	<b>Video Decoder</b> 4K@60fps H.264 AVC/MVC, H.265 HEVC/MVC, VP9 1080P@60fps MPEG-4/-2/-1/VC-1, VP8 <b>Video Encoder</b> 1080P@60fps H.264/AVC BP/MP/HP, H.265/HEVC MP
<b>ROM</b>	2GB/4GB (Up to 8GB) 32bit LPDDR4
<b>Storage</b>	16GB/32GB (Up to 256GB) EMMC
<b>Display Output</b>	1*HDMI2.0 (Up to 4K@60HZ) 1*LVDS/EDP (Up to 1920x1080) 1*MIPI (Up to 1920x1080)
<b>Display Input</b>	1*DVP-CSI-24PIN-FPC 1*MIPI-CSI-30PIN-BTB
<b>Audio</b>	1*SPK (L&R audio-out, Up to 2*8Ω/5W speaker) 1*HP (CTIA) 1*MIC 1*4G-MIC 1*4G-SPK (Single Track)
<b>Network</b>	Ethernet: Support 10/100/1000M GMAC WIFI: dual-band Wifi 6

	Bluetooth: 5.4 4G LTE: Support Mini_PCIE 4G/3G Module
USB	1*Type-C USB(OTG or HOST) 1*Type-A USB3.0 HOST 2*Type-A USB2.0 HOST 2*USB2.0 HOST(4Pin*2.0mm Wafer)
UART	3*TTL(2*optional TTL or RS232, 1* optional TTL or RS485)
Other	1*IIC 4*GPIO 1*CAN 3*Key (1*PWR_Key,2*Vol_Key)

## 1.4 Configuration & General Precautions

1. Relative humidity  $\leq 85\%$
2. Storage temperature:  $-30\text{ }^{\circ}\text{C}$  to  $+70\text{ }^{\circ}\text{C}$
3. Operating temperature:  $-15\text{ }^{\circ}\text{C}$  to  $+60\text{ }^{\circ}\text{C}$
4. During the assembly of the whole machine, please do not operate the wiring with power to avoid short circuit between bare board and peripheral equipment.
5. Pay attention to the anti-static treatment during the assembly and transportation of the whole machine, and it is necessary to wear electrostatic protection tools such as electrostatic bracelet (sleeve).
6. When assembling the whole machine, it can be installed at the bottom or side, but do not deform or twist the board, and do not bear heavy pressure.
7. Proper distance shall be reserved at the wiring position of each terminal to avoid squeezing the terminal during installation.
8. The connecting line between this board and the supporting module board should not be too long, otherwise it may affect the image quality.
9. The internal wiring of the whole machine shall be reasonable, and the connecting wires shall not pass through the PCB board directly as far as possible.
10. In order to achieve better EMC effect for the whole machine, it is recommended that the screen wire between the main board and the screen should be shielded wire.
11. The specifications of the peripherals connected to the installation shall be confirmed with our company, including but not limited to: voltage limit, current limit, timing, power domain, etc.

## Chapter 2 Interface Pin Name

### J55 (2PIN/2.0) 4G MIC

Exterior	Pin No.	Pin Name	Description
	1	MIC+	Positive input for 4G microphone
	2	MIC-	Negative input for 4G microphone

### J13 (2PIN/2.0) MIC

Exterior	Pin No.	Pin Name	Description
	1	MIC+	Positive input for local microphone
	2	MIC-	Negative input for local microphone

### J12 (4PIN/2.0) SPK

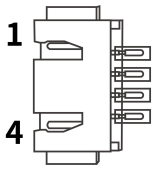
Exterior	Pin No.	Pin Name	Description
	1	RPK+	Positive output for right Channel
	2	RPK-	Negative output for right Channel
	3	LPK-	Negative output for left Channel
	4	LPK+	Positive output for left Channel

### J16、J25 (4PIN/2.0) 1.5A USB

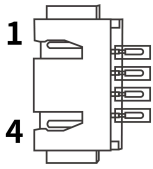
Exterior	Pin No.	Pin Name	Description
	1	+5V	USB Power Supply
	2	D-	USB data-
	3	D+	USB data+
	4	GND	Ground

### J7 (4PIN/2.0) PWR/VOL-/VOL+ Key

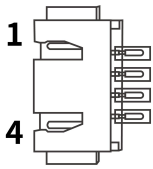
Exterior	Pin No.	Pin Name	Description
	1	K1	Volume up
	2	K2	Volume down
	3	PWR	Power on/off
	4	GND	Ground

**J3 (5PIN/2.0) IR+LED**

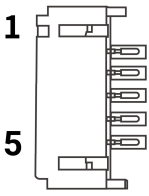
Exterior	Pin No.	Pin Name	Description
	1	VCC	3.3V Power Supply
	2	GND	Ground
	3	IR	Remote Control Infrared
	4	RED	Red Light
	5	GED	Green Light

**J8 (6PIN/2.0) GPIO (Power Domain3.3V)**

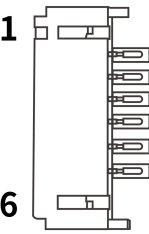
Exterior	Pin No.	Pin Name	Description
	1	3.3V	3.3V Power Supply
	2	IO1	GPIO1
	3	IO2	GPIO2
	4	IO3	GPIO3
	5	IO4	GPIO4
	6	GND	Ground

**J9 (6PIN/2.0) EDP/LVDS\_BL**

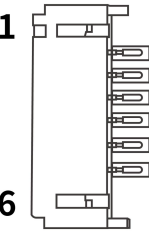
Exterior	Pin No.	Pin Name	Description
	1	GND	Ground
	2	GND	Ground
	3	ADJ	Backlight Brightness Adjustment
	4	EN	Backlight On/Off Control
	5	+12V	Screen Backlight Power Supply
	6	+12V	Screen Backlight Power Supply

**J29 (20PIN/2.0) EDP**

Exterior	Pin No.	Pin Name	Description
	1	PWR	Power Supply
	2	PWR	Power Supply
	3	GND	Ground
	4	GND	Ground
	5	TXON	EDP Signal
	6	TXOP	EDP Signal
	7	TX1N	EDP Signal
	8	TX1P	EDP Signal

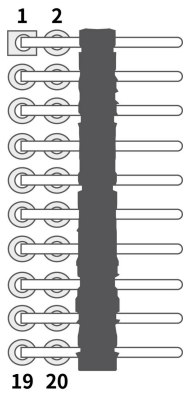
	9	TX2N	EDP Signal
	10	TX2P	EDP Signal
	11	TX3N	EDP Signal
	12	TX3P	EDP Signal
	13	GND	Ground
	14	GND	Ground
	15	AUXN	EDP Signal
	16	AUXP	EDP Signal
	17	GND	Ground
	18	GND	Ground
	19	GND	Ground
	20	HPD	Plug and Pull Detection

**J28(6PIN/2.0) LVDS\_SEL\_VOLT**

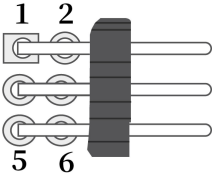
Exterior	Pin No.	Pin Name	Description
	1	12V	12V Power Supply
	2	VCC_LCD	Screen Voltage Port
	3	5V	5V Power Supply
	4	VCC_LCD	Screen Voltage Port
	5	3.3V	3.3V Power Supply
	6	VCC_LCD	Screen Voltage Port

**Note: The LVDS screen uses a jumper cap to select the screen power supply. Connect 3.3V to VCC\_LCD, then the screen voltage is 3.3V.**

**J15 (30PIN/2.0) LVDS**

Exterior	Pin No.	Pin Name	Description
	1	PWR	Power Supply
	2	PWR	Power Supply
	3	PWR	Power Supply
	4	GND	Ground
	5	GND	Ground
	6	GND	Ground
	7	DON	LVDS Signal
	8	DOP	LVDS Signal
	9	D1N	LVDS Signal
	10	D1P	LVDS Signal
	11	D2N	LVDS Signal
	12	D2P	LVDS Signal
	13	GND	Ground

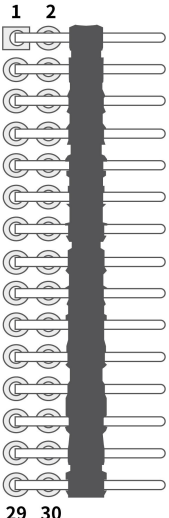
	14	GND	Ground
	15	CLKON	LVDS Signal
	16	CLKOP	LVDS Signal
	17	D3N	LVDS Signal
	18	D3P	LVDS Signal
	19	D5N	LVDS Signal
	20	D5P	LVDS Signal
	21	D6N	LVDS Signal
	22	D6P	LVDS Signal
	23	D7N	LVDS Signal
	24	D7P	LVDS Signal
	25	GND	Ground
	26	GND	Ground
	27	CLK1N	LVDS Signal
	28	CLK1P	LVDS Signal
	29	D8N	LVDS Signal
30	D8P	LVDS Signal	

**J6 (2PIN/1.25) RTC Battery**

Exterior	Pin No.	Pin Name	Description
	1	+	Battery Positive
	2	-	Battery Negative

**J505 (4PIN/1.25) CAN**

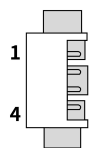
Exterior	Pin No.	Pin Name	Description
	1	VCC	Power supply 5V
	2	CANH	CAN Trunk
	3	CANL	CAN Trunk
	4	VSS	Ground

**J20 (4PIN/2.0) UART 0 (TTL, Optional RS485,TTL Power Domain 3.3V)**

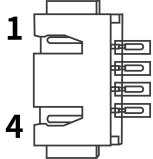
Exterior	Pin No.	Pin Name	Description
	1	VCC	Power supply 5V (3.3V optional)
	2	RX0/485B	UART Receive
	3	TX0/485A	UART Transmit
	4	GND	Ground

**J23 (4PIN/2.0) UART 8 (TTL, Optional RS232, TTL Power Domain 3.3V)**

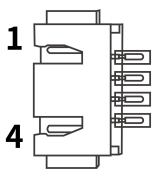
Exterior	Pin No.	Pin Name	Description
	1	VCC	Power supply 5V (3.3V optional)
	2	RX8	UART Receive
	3	TX8	UART Transmit
	4	GND	Ground

**J17 (4PIN/2.0) UART 2 (Debug UART, TTL, Optional RS232, Power Domain 3.3V)**

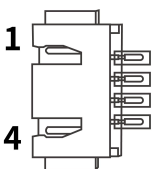
Exterior	Pin No.	Pin Name	Description
	1	VCC	Power supply 5V (3.3V optional)
	2	RX2	UART Receive
	3	TX2	UART Transmit
	4	GND	Ground

**J24 (6PIN/2.0) 12V\_OUT and 12V PWR\_IN**

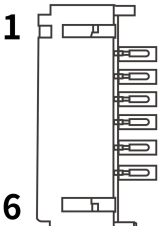
Exterior	Pin No.	Pin Name	Description
	1	12V-IN	12V Power Input
	2	12V-IN	12V Power Input
	3	GND	Ground
	4	GND	Ground
	5	12V-OUT	12V Power Output
	6	12V-OUT	12V Power Output

**J2 (4PIN/2.0) POE\_PWR**

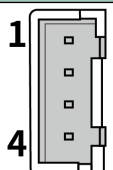
Exterior	Pin No.	Pin Name	Description
	1	CT1	Communication Data1
	2	CT3	Communication Data3
	3	CT4	Communication Data4
	4	CT5	Communication Data5

**J9116 (2PIN/1.25) 4G SPK**

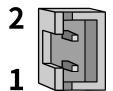
Exterior	Pin No.	Pin Name	Description
	1	SPKP	4G Speaker Positive Output
	2	SPKN	4G Speaker Negative Output

**J21 (24PIN/0.5) DVP\_CSI (FPC) (Back Interface)**

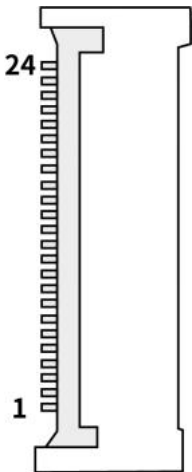
Exterior	Pin No.	Pin Name	Description
	1	CIF_PDN1	CIF_PDN1
	2	GND	Ground
	3	I2CO_SDA	IIC Data
	4	AVDD	2.8V Power
	5	I2CO_SCL	IIC Clock
	6	CIF_RST	CIF Reset
	7	CIF_VSYNC	CIF_VSYNC
	8	CIF_PWDN-F	CIF_PWDN-F
	9	CIF_HREF	CIF_HREF
	10	VCC18_DVP	1.8V Power
	11	VCC28_DVP	2.8V Power
	12	CIF_D7	CIF_D7
	13	CIF_HCLKOUT	CIF_HCLKOUT
	14	CIF_D6	CIF_D6
	15	GND	Ground
	16	CIF_D5	CIF_D5
	17	CIF_PCLKIN	CIF_PCLKIN
	18	CIF_D4	CIF_D4
	19	CIF_D0	CIF_D0
	20	CIF_D3	CIF_D3
	21	CIF_D1	CIF_D1
	22	CIF_D2	CIF_D2
	23	NC	Null
	24	NC	Null

**J5 (10PIN/0.5 FPC) TP(IIC) (Back Interface)**

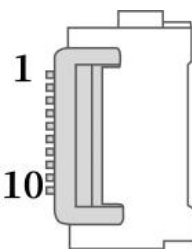
Exterior	Pin No.	Pin Name	Description
	1	GND	Ground
	2	GND	Ground
	3	RST	Reset
	4	INT	interrupt
	5	GND	Ground
	6	SCL	Data
	7	SDA	Clock
	8	VCC	Power
	9	GND	Ground
	10	GND	Ground

## J22(30PIN/0.4) MIPI\_CSI (BTB) (Back Interface)

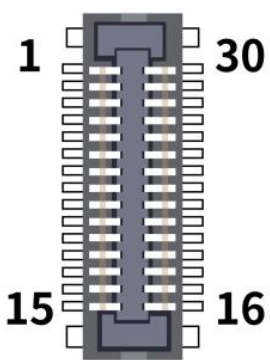
Exterior	Pin No.	Pin Name	Description
	1	GND	Ground
	2	MIPI_MCLK	MIPI Signal
	3	GND	Ground
	4	GIF_PDN1	GIF_PDN1
	5	MIPI_RST	Data
	6	SDA	IIC Data
	7	SCL	IIC Clock
	8	GND	Ground
	9	VCC_DVP	2.8V Power
	10	GND	Ground
	11	VCC	2.8V Power
	12	GND	Ground
	13	VCC	1.8V Power
	14	VCC	1.8V Power
	15	GND	Ground
	16	GND	Ground
	17	MIPI_D0N	MIPI Signal
	18	MIPI_D0P	MIPI Signal
	19	GND	Ground
	20	MIPI_D1N	MIPI Signal
	21	MIPI_D1P	MIPI Signal
	22	GND	Ground
	23	MIPI_CLKN	MIPI Signal
	24	MIPI_CLKP	MIPI Signal
	25	GND	Ground
	26	MIPI_D2N	MIPI Signal
	27	MIPI_D2P	MIPI Signal
	28	GND	Ground
	29	MIPI_D3N	MIPI Signal
	30	MIPI_D3P	MIPI Signal

## Chapter 3 Electrical Characteristics

### ◆ Normal Operating Conditions

Interface Type		Min	Typ	Max
Standard power parameters	Vcc	11V	12V	13.5V
	Ripple	/	/	±3%
	Current	2A	3A	/

### ◆ Power Consumption

Interface Type		Min	Typ	Max
Power Supply Current (with no display connected )	Operation Current	/	220mA	500mA
	STAND-BY CURRENT	/	10mA	10mA
	BATTERY OPERATION CURRENT	/	0.00098mA	/

### ◆ USB Power Supply

USB Interface Type	Voltage	Typical Current	Max Current
OTG_USB	5V	500mA	1.3A
HOST_USB	5V	500mA	1.3A

### ◆ Other

Interface Type	Rated Current	Max Current	Max Current
EXT 5V	/	3000mA	
EXT 3.3V	/	3000mA	

## Chapter 4 System Instruction

### 4.1 Android System Interface Description

The main menu interface of Android system is divided into four categories: application, settings, file management and browser.

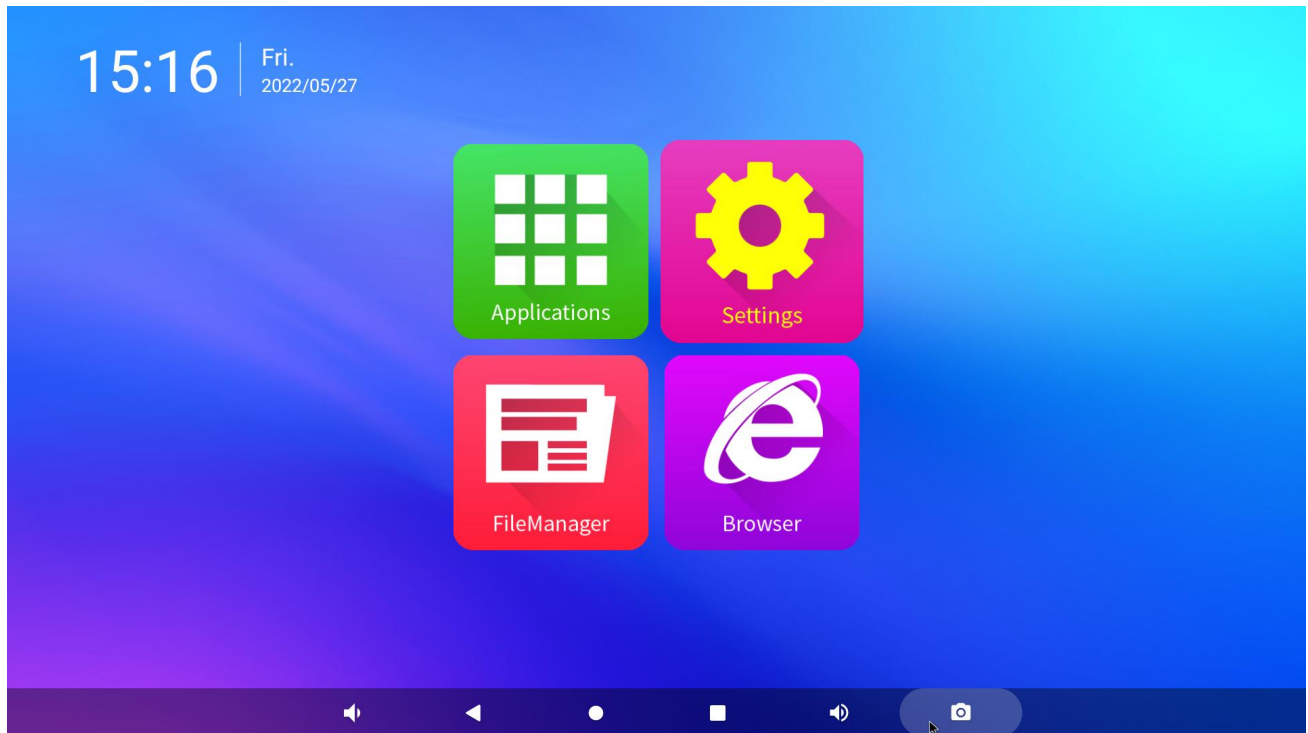

Homepage

#### (1) Application interface

The application interface includes: Power on / off, settings, gallery, file, camera, music, explorer, browser, etc.

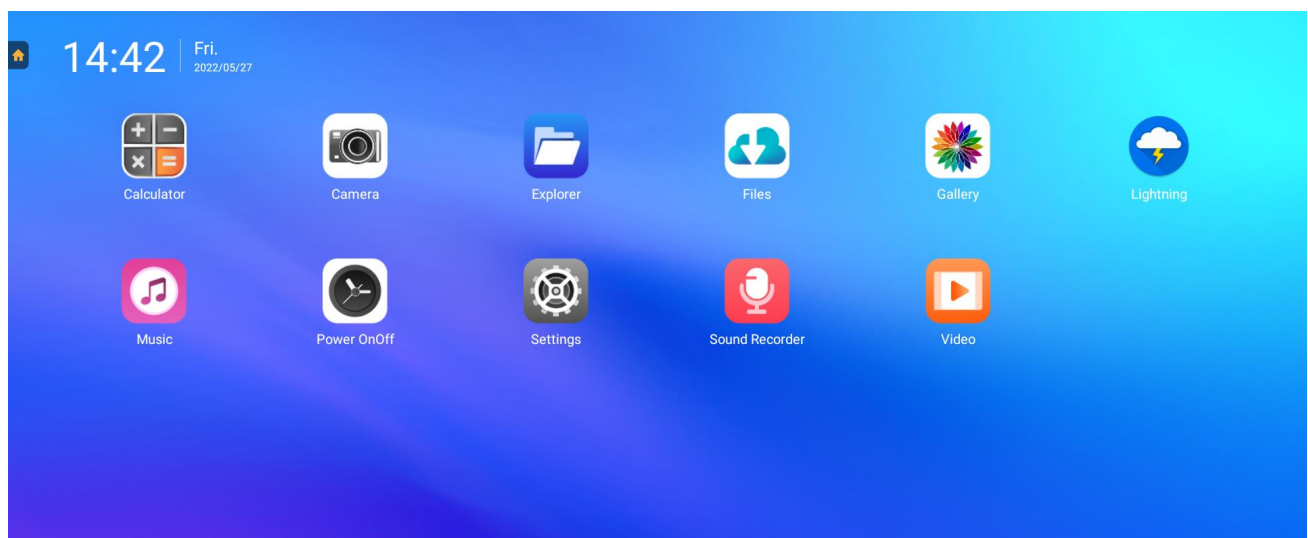

Application Interface

### (2) File Management Interface

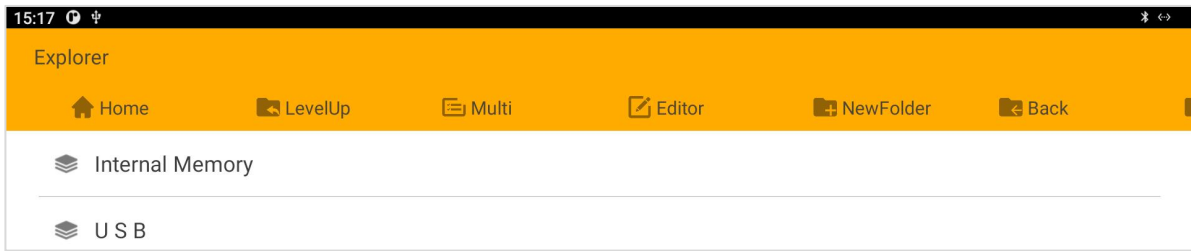

File Management Interface

### (3) Setting Menu Interface

It supports the settings of wireless network and device display sound, and can also view the program applications installed on the device, storage memory, etc.

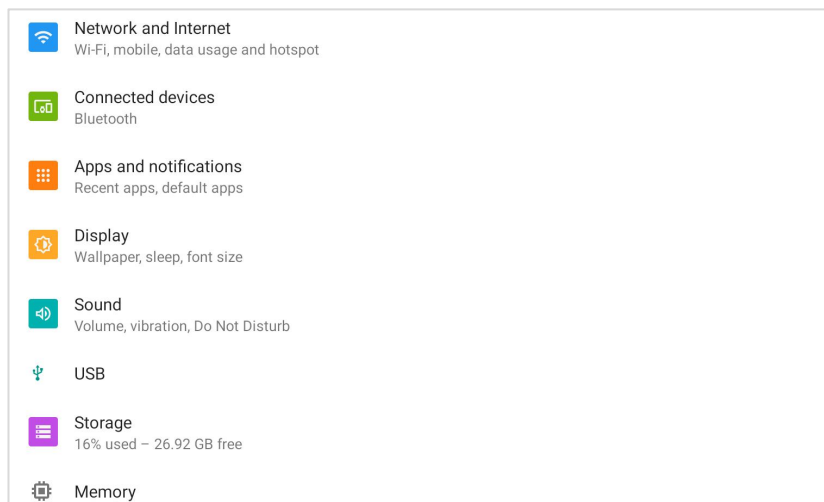

Setting Menu Interface

## 4.2 Network Interface Explanation

### (1) WIFI Network Signal Connection

Turn on the WiFi switch in the "setting" interface, as shown in the following figure; Select the WiFi signal to be connected and enter the corresponding password to successfully connect.

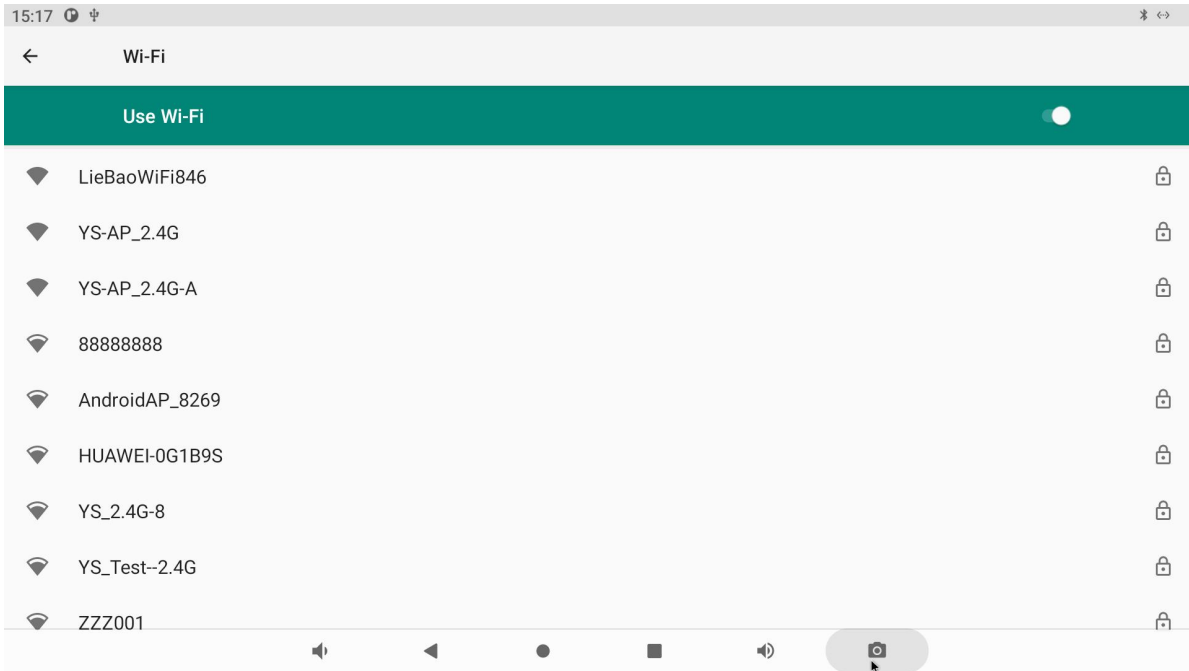

WIFI Setting Interface

### (2) WiFi Hotspot

As shown in the following figure, in the "Settings - network and Internet" interface, open the "hotspot and network sharing - WiFi hotspot" function, enter the interface shown in the figure below, you can send WiFi signals, and the device can successfully connect to the hotspot by entering the password.

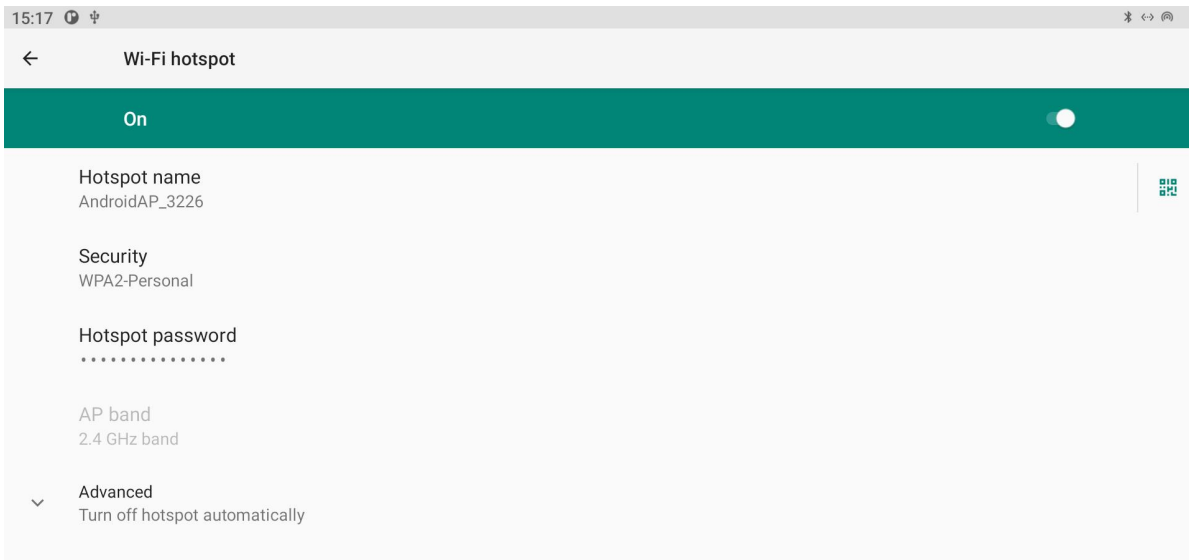

WIFI Hotspot connection interface

### (3) Bluetooth Signal Connection

In the "Settings" interface, open the "connected devices" function and enter the "pairing with new devices" interface shown in the figure below to search for Bluetooth devices and pair them.

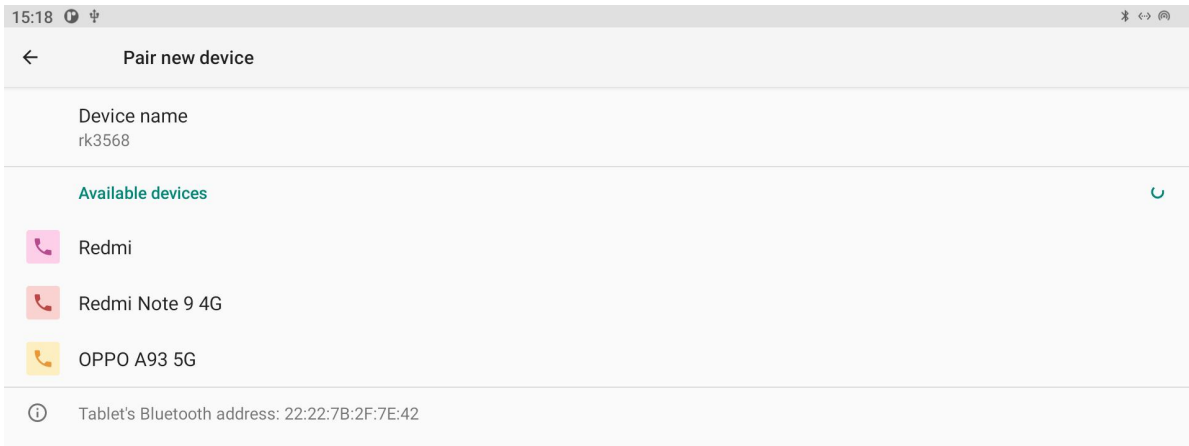

Bluetooth Setting Interface

#### (4) Ethernet Connection

In the "Settings" interface, enter "network and Internet", turn on Ethernet, enter the page shown in the figure below, turn on the Ethernet switch, then plug in the network cable and automatically connect to Ethernet. You can view the IP address, Ethernet MAC address and other information in the interface shown in the figure below.

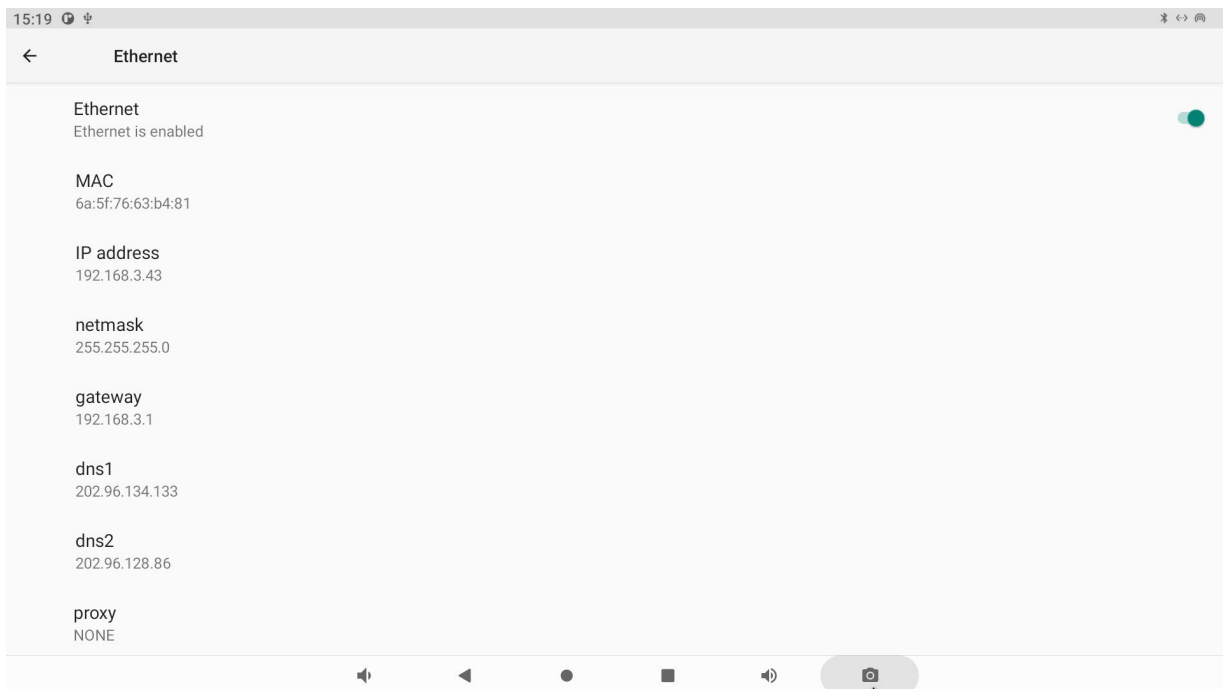

Ethernet Setting Interface

**NOTICE:**

- THE USE OF THE WIRELESS NETWORK MUST BE CONNECTED TO THE WIFI ANTENNA AT THE WIFI ANTENNA HOLDER
- THE AVAILABILITY AND COVERAGE OF WIFI SIGNALS DEPENDS ON THE NUMBER OF SIGNALS, ANTENNA PERFORMANCE AND EXTERNAL ENVIRONMENT.
- THE ETHERNET MAC ADDRESS IS THE ONLY PERMANENT AND VALID DEVICE ID FOR THIS SYSTEM.

THE NETWORK PRIORITY ORDER FOR ALL ANDROID DEVICES IS:

- 1. ETH Ethernet network
- 2. WIFI wireless network
- 3. 3G/4G/5G mobile network

### 4.3 Viewing Storage and Memory

In settings, select "storage" to enter the following interface, where the storage information of the storage space will be displayed. The display of 5.08GB capacity is the remaining available storage capacity of the board, and the display of "Total used 32.00GB" is the total storage capacity of the hardware.

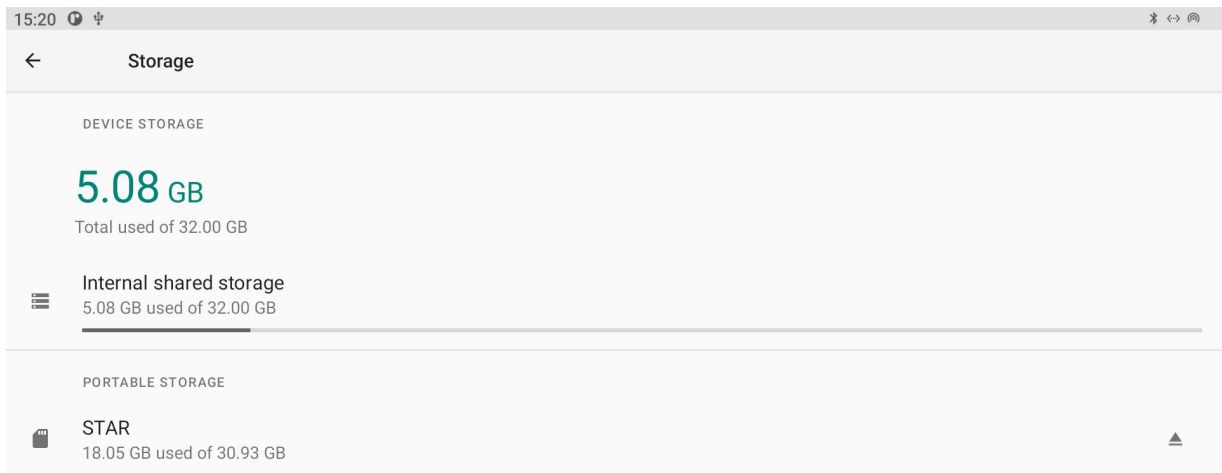

Viewing Storage Interface

In the setting, select "memory" to enter the interface below to display the built-in storage information. The display shows that the capacity of 1.3GB is the remaining memory capacity of the board, and the display of "total memory 4GB" is the total memory.

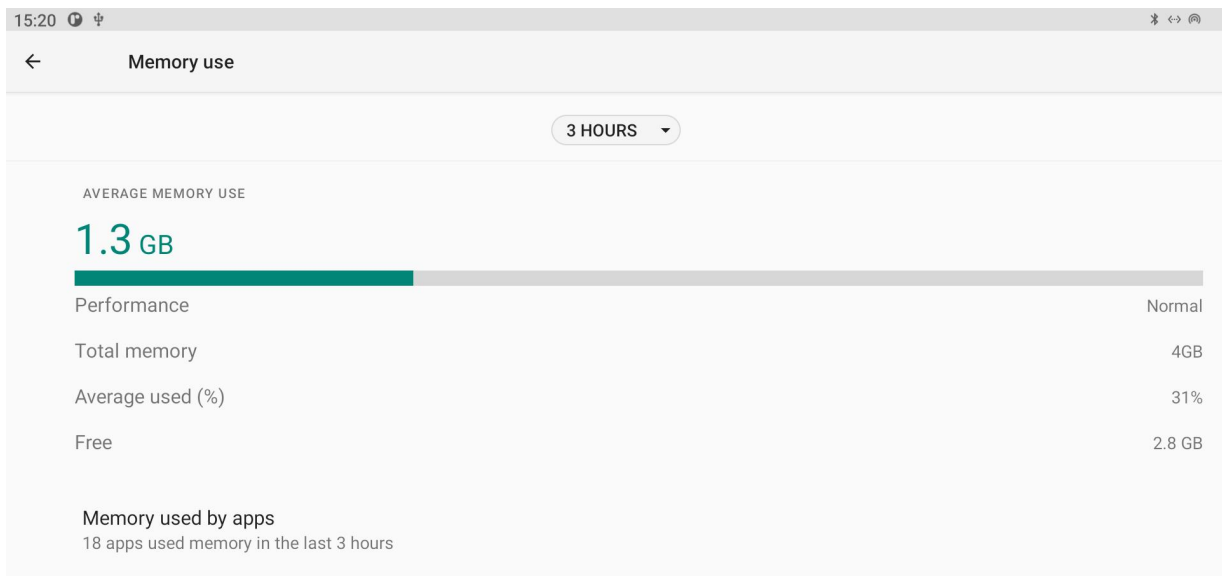

View Memory Interface

## 4.4 Setting The Notification Bar And Navigation Bar

In the setting, select "display": check "hide navigation bar", and the navigation bar will be hidden; Check "swipe navigation bar", and the navigation bar can be slid out by sliding the mouse up from the bottom. The navigation bar will disappear 5 seconds after no operation. If disable expand statusbar is checked, expand statusbar cannot be pulled down; Check "hide top statusbar" to hide the top statusbar showing time and other statuses at the top of the interface.

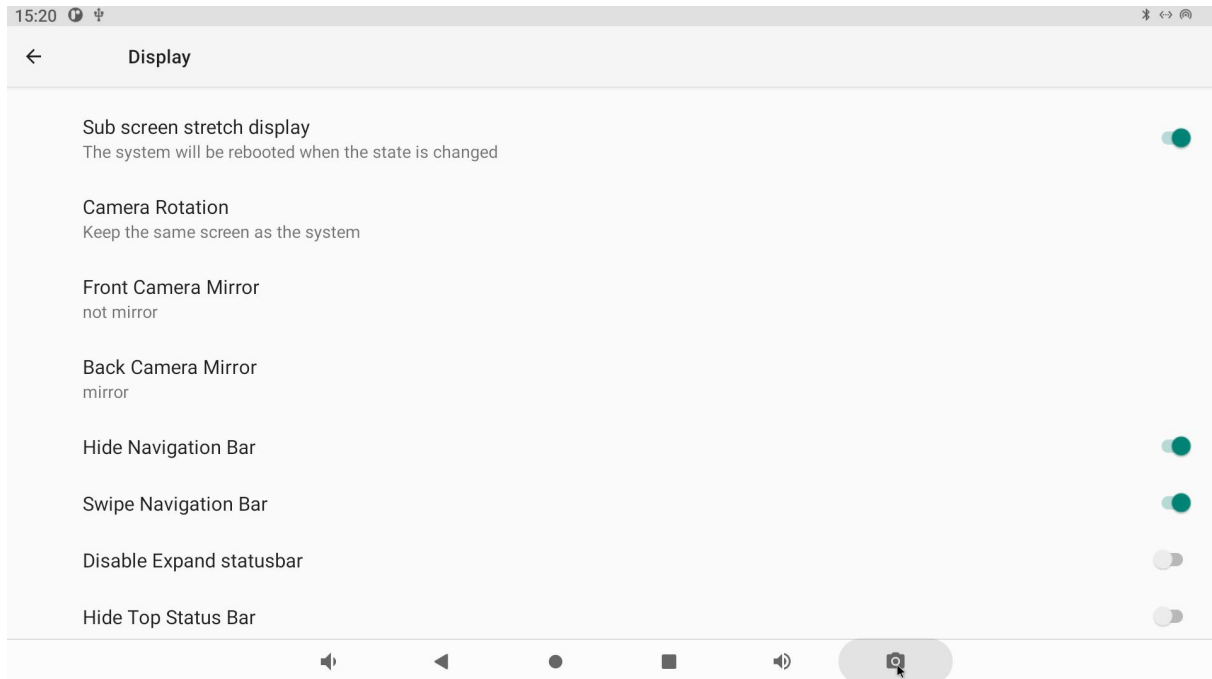

Navigation Bar

**NOTE:**

"Hide navigation bar" must be selected before "swipe navigation bar" is selected;

When hide top statusbar is selected, expand statusbar is also forced to be hidden by default.

## Chapter 5 Contact Us



**Contact Information:**

**Tel:** 0755-27383670

**Email:** [lisiping@yishengtc.com](mailto:lisiping@yishengtc.com)

**Operation Website:**

**Web:** [www.yishengtec.cn/en](http://www.yishengtec.cn/en)

**Office Address:**

**Shenzhen Headquarters:** 6/F, R&D Center, Lixinhu High-tech Industrial Park, Bao'an District, Shenzhen

**Guangzhou Branch:** Room 318, Jiangrun Building, No. 565, Xingnan Avenue, Panyu District, Guangzhou

*[Looking forward to working with you, thank you](#)*